

cierre1972

chapeau
clift
season
iole
jamiro
woody
vogue cuoio bed
jared bed
lip
fly
riviera
zed
byron
tappo
helix
dino
dama
jared bench
vogue cuoio bench
cushions

COLLECTION24

cierre1972

COLLECTION24

I have recently read the marvelous book by the 122nd Captain of the Amerigo Vespucci. The feeling he conveyed in the introduction has fully resonated with me, a feeling that goes past our shared passion for the sea and that I carry with me every single day in Cierre: the ability to look beyond. "The higher the vantage point, the wider your optical horizon; it allows you to look far beyond, further than those who remain on the ground only gazing at what is close and near. Naturally, this notion can apply to situations falling outside of the mere spatial dimension, to circumstances where the search for new challenges can push you to reconsider your own aspirations and raise the bar of your personal and professional ambitions. Ultimately, achieving success has awarded me with the embrace from my crew, which is the most valuable prize one can obtain. Holding fast to my travel companions was and continues to embody the profound symbiosis of passion and emotion. It grants me the energy to look further up, brushing the limits of my capabilities and dreams." Quote from "Il punto più alto" (trad. The highest point), by Gianfranco Bacchi, ed. Cinque Terre.

Ho letto da poco un libro meraviglioso scritto dal centotridicesimo Comandante dell'Amerigo Vespucci. Nella premessa ha espresso un pensiero che mi sento di condividere in pieno e nel quale mi identifico, e non parlo solo della passione per il mare, ma anche di quel sentimento, quella capacità di guardare oltre, che mi piace vivere tutti in giorni in Cierre. "Il punto più alto aumenta l'orizzonte ottico, permette di guardare oltre, rispetto a colui che decide di non elevarsi e accetta di vedere solo quello che gli è più vicino e alla portata. Naturalmente questo concetto si apre a paralleli che esulano dall'aspetto spaziale per abbracciare situazioni in cui la ricerca di nuove sfide spinge a rivedere le proprie aspirazioni e ad alzare l'asticella delle ambizioni personali e professionali. Alla fine, il conseguimento del successo mi ha premiato concedendomi l'abbraccio del mio equipaggio che è quanto di più prezioso si possa ottenere. Potermi stringere ai compagni di avventura in un contatto che ha rappresentato e rappresenta l'intima osmosi di passione ed emozioni, mi regala la carica per guardare sempre più in alto fino a sfiorare i limiti delle mie capacità e dei miei sogni." Cit. da "Il punto più alto" di Gianfranco Bacchi, edizioni Cinque Terre.

Stefano Conficconi

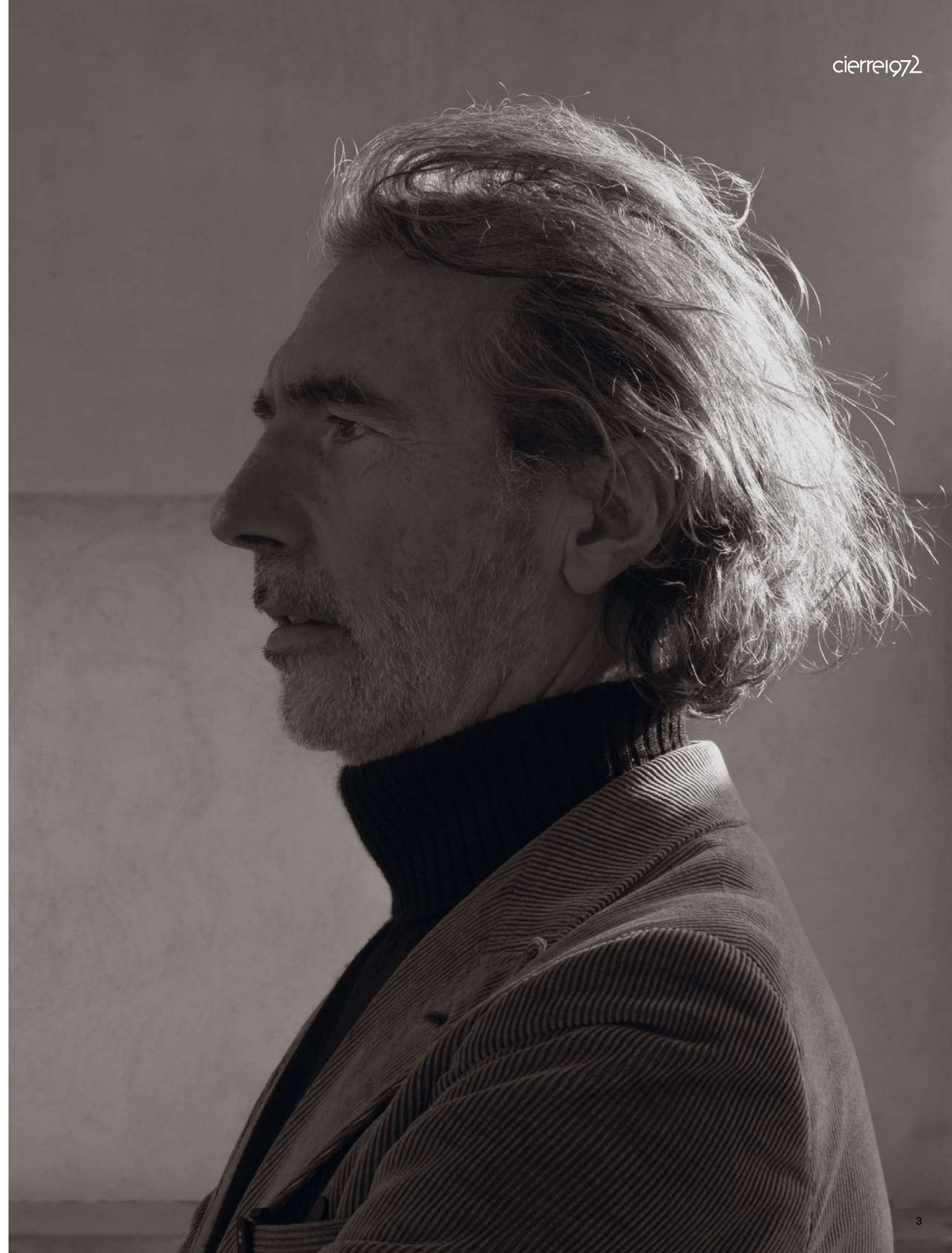

SOFAS
DIVANI

chapeau 10



clift 46



season 58



ARMCHAIRS
POLTRONE

iole 70



jamiro 80



woody 90



BEDS
LETTI

vogue
cuoio
bed 94



jared
bed 104



SIDEBOARDS
MADIE

lip 116



fly 124



TABLES
TAVOLI

riviera 128



zed 134



**COFFEE
TABLES**
TAVOLINI

byron 138



tappo 144



helix 150



**BEDSIDE
TABLES**
COMODINI

dino 154



ACCESSORIES
ACCESSORI

dama 158



jared
bench 170



vogue
cuoio
bench 176



cushions 180





THE NEW FACET OF RESEARCH AND BEAUTY.
LA NUOVA DIMENSIONE DEL CONCETTO DI RICERCA E BELLEZZA.



This year, we wanted to present and stage our new products within three different architectural contexts, each imbued with a unique sense of style, personally and harmonically rearranged to fit their natural environment. From the experimental rationalism of Catalonia, where the constructions of vaults are fused and confused with the unique shapes of maritime pines; to the Brianzan villa, a full-fledged museum where even the garden becomes an open-air exposition; and finally, the house in Milan, where the garden is part of the interior in an example of spatial optimization. The new '24 collection is draped with natural shades and materials deeply connected to nature, such as travertine marble, wood, and hand-woven leather, referencing an essential, nearly primal style. Quest'anno abbiamo voluto raccontare i nuovi prodotti all'interno di tre differenti contesti architettonici sintesi di stili unici, ognuno di essi armonizzato in un modo del tutto personale nel contesto naturale. Dal razionalismo sperimentale catalano, dove la costruzione delle volte si fonde e confonde con le forme uniche dei pini marittimi, alla villa brianzea museo a tutto tondo, dove anche il giardino diventa un'esposizione a cielo aperto, fino alla casa milanese dove il giardino si organizza all'interno, in un'esemplare ottimizzazione degli spazi. La nuova collezione 24 si veste di sfumature dai toni naturali e dai materiali che vogliono essere connessi alla natura come il marmo travertino, il legno e la pelle con l'inserimento della lavorazione intrecciata a mano, per un richiamo ad uno stile quasi primitivo ed essenziale.



**CHAPEAU IS A MASTERPIECE OF ELEGANT VERSATILITY,
ADAPTABLE TO ANY DESIRE OF COMFORT.
CHAPEAU È CAPOLAVORO DI ELEGANTE VERSATILITÀ
CHE SI ADATTA A QUALSIASI DESIDERIO DI COMFORT.**

chapeau

STEFANO CONFICCONI

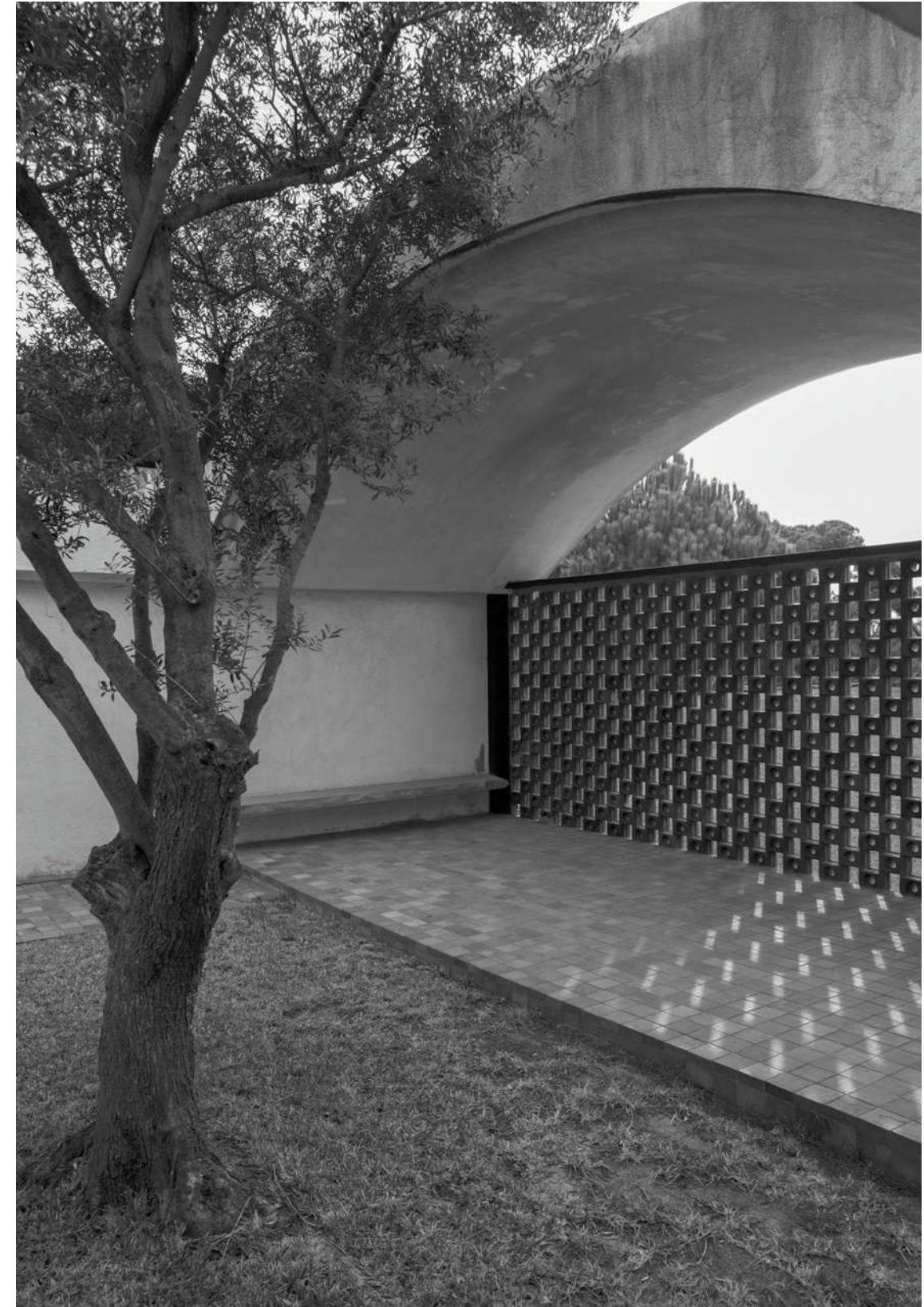

Chapeau sectional el. 09+37 in fabric Lario 65, profile in leather Setanil 75, Champagne effect painted metal legs Soft Touch finish. **Jamiro armchair** el. 1 in leather Setanil 75, black chromed metal structure. **Tappo coffee tables** el. TM in leather Setanil 80, top in solid Canaletto walnut wood + el. TP in leather Natural Velour 50, top in Travertine stone + el. TM in leather Natural Velour 50, top in Travertine stone + el. TP in leather Setanil 75, top in solid Canaletto walnut wood. **Iceberg coffee tables** el. TG top in marble white wood, lacquered metal legs RAL 9002.

Chapeau componibile el. 09+37 in tessuto Lario 65, profilo in pelle Setanil 75, piedi in metallo verniciato colore Champagne finitura Soft Touch. **Jamiro poltrona** el. 1 in pelle Setanil 75, struttura in metallo cromato nero. **Tappo tavolini** el. TM in pelle Setanil 80, piano in legno massello Noce Canaletto + el. TP in pelle Natural Velour 50, piano in Travertino + el. TM in pelle Natural Velour 50, piano in Travertino + el. TP in pelle Setanil 75, piano in legno massello Noce Canaletto. **Iceberg tavolini** el. TG piano in marmo white wood, piedi in metallo laccato RAL 9002.





Chapeau sectional el. 09+37 in fabric Lario 65, profilo in leather Setanil 75, Champagne effect painted metal legs Soft Touch finish. **Tappo coffee tables** el. TM in leather Natural Velour 50, top in Travertine stone + el. TP in leather Setanil 75, top in solid Canaletto walnut wood.

Chapeau componibile el. 09+37 in tessuto Lario 65, profilo in pelle Setanil 75, piedi in metallo verniciato colore Champagne finitura Soft Touch. **Tappo tavolini** el. TM in pelle Natural Velour 50, piano in Travertino + el. TP in pelle Setanil 75, piano in legno massello Noce Canaletto.



Chapeau feet Champagne effect painted metal legs Soft Touch finish.
Chapeau in metallo verniciato colore Champagne finitura Soft Touch.



Chapeau sectional el. 09+37 in fabric Lario 65, profile in leather Setanil 75, champagne effect painted metal legs Soft Touch finish. **Jamiro armchair** el. 1 in leather Setanil 75, black chromed metal structure. **Tappo coffee tables** el. TM in leather Setanil 80, top in solid Canaletto walnut wood + el. TP in leather Natural Velour 50, top in Travertine stone + el. TM in leather Natural Velour 50, top in Travertine stone + el. TP in leather Setanil 75, top in solid Canaletto walnut wood. **Iceberg coffee tables** el. TG top in marble white wood, lacquered metal legs RAL 9002.

Chapeau componibile el. 09+37 in tessuto Lario 65, profilo in pelle Setanil 75, piedi in metallo verniciato colore Champagne finitura Soft Touch. **Jamiro poltrona** el. 1 in pelle Setanil 75, struttura in metallo cromato nero. **Tappo tavolini** el. TM in pelle Setanil 80, piano in legno massello Noce Canaletto + el. TP in pelle Natural Velour 50, piano in Travertino + el. TM in pelle Natural Velour 50, piano in Travertino + el. TP in pelle Setanil 75, piano in legno massello Noce Canaletto. **Iceberg tavolini** el. TG piano in marmo white wood, piedi in metallo laccato RAL 9002.



THE HOUSE OF THE ARCHITECT
IS SYNONYMOUS WITH ESSENTIAL
LINES DEFINING EACH SPACE.
LA CASA DELL'ARCHITETTO
È SINONIMO DI LINEE ESSENZIALI
CHE DEFINISCONO GLI SPAZI.

Chapeau sectional el. 19+28 in fabric Vellus 08, profile in leather Setanil 76, black chromed metal legs. **Iole armchair** el. 1 in leather Natural Velour 98, armrests in black painted ash wood with Setanil 10 woven leather. **Soft ottoman** el. P80 in leather Setanil 10, pattern Stampa Quadri. **Tappo coffee tables** el. TM in leather Setanil 80, top in solid Canaletto walnut wood. **Helix coffee tables** el. TAT + TBT in leather Setanil 76, top in bronze tinted glass, black chromed metal base. **Lip sideboard** el. CZ in Canaletto walnut wood, top detail in Travertine stone, black chromed metal legs.

Chapeau componibile el. 19+28 in tessuto Vellus 08, profilo in pelle Setanil 76, piedi in metallo cromato nero. **Iole poltrona** el. 1 in pelle Natural Velour 98, braccioli in legno massello Frassino Nero e pelle intrecciata Setanil 10. **Soft pouf** el. P80 in pelle Setanil 10, motivo Stampa Quadri. **Tappo tavolini** el. TM in pelle Setanil 80, piano in legno massello Noce Canaletto. **Helix tavolini** el. TAT + TBT in pelle Setanil 76, piano in vetro bronzo, basamento in metallo cromato nero. **Lip madia** el. CZ in legno Noce Canaletto, dettaglio del top in Travertino, piedi in metallo cromato nero.





Chapeau sectional el. 19+28 in fabric Vellus 08, profilo in leather Setanil 76, black chromed metal legs. **Soft ottoman** el. P80 in leather Setanil 10, pattern Stampa Quadri. **Tappo coffee tables** el. TM in leather Setanil 80, top in solid Canaletto walnut wood. **Helix coffee tables** el. TAT + TBT in leather Setanil 76, top in bronze tinted glass, black chromed metal base. **Lip sideboard** el. CZ in Canaletto walnut wood, top detail in Travertine stone, black chromed metal legs.

Chapeau componibile el. 19+28 in tessuto Vellus 08, profilo in pelle Setanil 76, piedi in metallo cromato nero. **Soft pouf** el. P80 in pelle Setanil 10, motivo Stampa Quadri. **Tappo tavolini** el. TM in pelle Setanil 80, piano in legno massello Noce Canaletto. **Helix tavolini** el. TAT in pelle Setanil 76, piano in vetro bronzo, basamento in metallo cromato nero. **Lip madia** el. CZ in legno Noce Canaletto, dettaglio del top in Travertino, piedi in metallo cromato nero.





Chapeau sectional el. 19+28 in fabric Vellus 08, profilo in leather Setanil 76, black chromed metal legs. **Iole armchair** el. 1 in leather Natural Velour 98, armrests in black painted ash wood with Setanil 10 woven leather. **Helix coffee tables** el. TAT + TBT in leather Setanil 76, top in bronze tinted glass, black chromed metal base.

Chapeau componibile el. 19+28 in tessuto Vellus 08, profilo in pelle Setanil 76, piedi in metallo cromato nero. **Iole poltrona** el. 1 in pelle Natural Velour 98, braccioli in legno massello Frassino Nero e pelle intrecciata Setanil 10. **Helix tavolini** el. TAT + TBT in pelle Setanil 76, piano in vetro bronzo, basamento in metallo cromato nero.

AN OPEN-AIR MUSEUM ILLUSTRATING
THE CONNECTION BETWEEN ARCHITECTURE,
MAN AND NATURE. **UN MUSEO A CIELO**
APERTO PER RACCONTARE LA CONNESSIONE
TRA ARCHITETTURA, UOMO E NATURA.

cierre1972

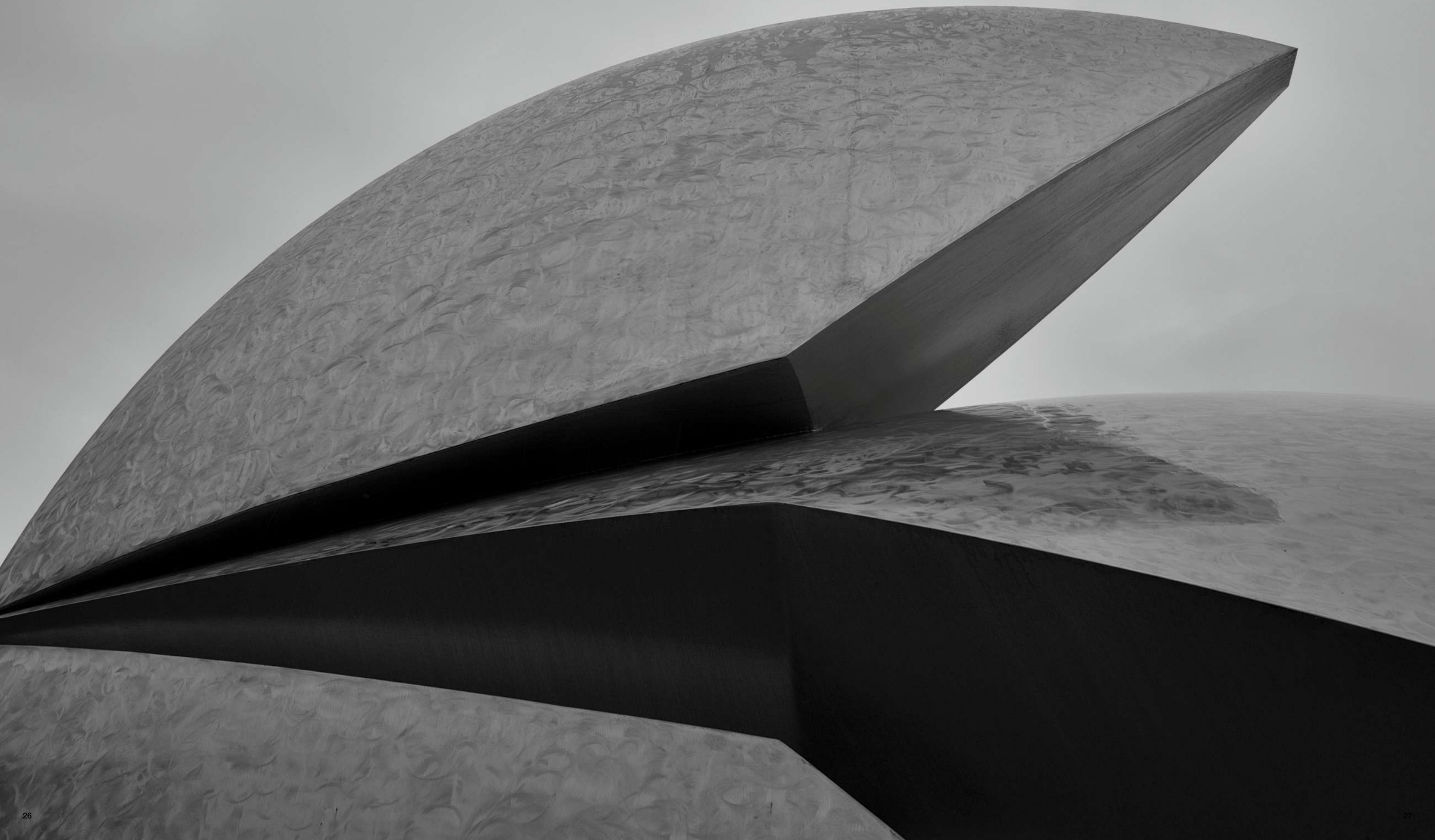

Chapeau modular sofa with metal structure and elastic belts support. The seat is composed of a seating cushion made of expanded polyurethane foam with two densities and acrylic silicon fiber, all covered with a layer of acrylic fiber. The backrests and armrests are in metal with reclining mechanism and are covered with a layer of expanded polyurethane, further covered with acrylic silicon fiber. The deco pillows are upholstered with acrylic silicon fiber. The metal feet are available in three different finishes: painted champagne effect, painted black and black chromed. The leather covering the profile is available in Soffio, Setanil and Natural Velour.

Chapeau divano modulare con struttura in metallo e supporto di nastri elastici. Seduta composta da un cuscino in poliuretano espanso in 2 densità e fibra acrilica siliconata, il tutto ricoperto da uno strato di falda acrilica. Schienali e braccioli in metallo reclinabili avvolti da uno strato di poliuretano espanso, a loro volta ricoperti da uno strato di fibra acrilica siliconata. I cuscini decorativi sono imbottiti con fibra acrilica siliconata. I piedi sono in metallo, disponibili in 3 diverse finiture: verniciato effetto champagne, verniciato nero o cromato nero. Il profilo è rivestito in pelle disponibile a scelta tra Soffio, Setanil e Natural Velour.





Chapeau sofa el. SX in leather Natural Velour 50, profile in leather Setanil 76, Champagne effect painted metal legs, Soft Touch finish + el. DRM in fabric Formentera 06, profile in leather Setanil 76, Champagne effect painted metal legs Soft Touch finish. **Jamiro armchair** el. 1 in leather Natural Velour 97, matt black painted metal structure. **Tappo coffee tables** el. TM in leather Setanil 80, top in solid Canaletto walnut wood. **Dama coffee tables** el. TP2 in leather Natural Velour 97, top in Travertine stone + el. TG2 in leather Natural Velour 50, top in Travertine stone. **Dama baskets** el. TM1 in leather Setanil 42. **Vogue cuoio bench** el. PAN in leather Setanil 76, black chromed legs. **Riviera dining table** el. X25, black ash wood, black chromed metal legs.

Chapeau divano el. SX in pelle Natural Velour 50, profilo in pelle Setanil 76, piedi in metallo verniciato colore Champagne finitura Soft Touch. + el. DRM in tessuto Formentera 06, profilo in pelle Setanil 76, piedi in metallo verniciato colore Champagne finitura Soft Touch. **Jamiro poltrona** el. 1 in pelle Natural Velour 97, struttura in metallo verniciato nero. **Tappo tavolini** el. TM in pelle Setanil 80, piano in legno massello Noce Canaletto. **Dama tavolini** el. TP2 in pelle Natural Velour 97, piano in Travertino + el. TG2 in pelle Natural Velour 50, piano in Travertino. **Dama cesti** el. TM1 in pelle Setanil 42. **Vogue cuoio panca** el. PAN in pelle Setanil 76, piedi in metallo cromato nero. **Riviera tavolo** el. X25 in legno Frassino nero, piedi in metallo cromato nero.

Chapeau sofa el. SX in leather Natural Velour 50, profile in leather Setanil 76, Champagne effect painted metal legs, Soft Touch finish + el. DRM in fabric Formentera 06, profile in leather Setanil 76, Champagne effect painted metal legs Soft Touch finish. **Tappo coffee tables** el. TM in leather Setanil 80, top in solid Canaletto walnut wood. **Vogue cuoio bench** el. PAN in leather Setanil 76, black chromed metal legs. **Picture right page** el. DRM in fabric Formentera 06, profile in leather Setanil 76, Champagne effect painted metal legs Soft Touch finish.

Chapeau divano el. SX in pelle Natural Velour 50, profilo in pelle Setanil 76, piedi in metallo verniciato colore Champagne finitura Soft Touch + el. DRM in tessuto Formentera 06, profilo in pelle Setanil 76, piedi in metallo verniciato colore Champagne finitura Soft Touch. **Tappo tavolini** el. TM in pelle Setanil 80, piano in legno massello Noce Canaletto. **Vogue cuoio panca** el. PAN in pelle Setanil 76, piedi in metallo cromato nero. **Foto pagina di destra** el. DRM in tessuto Formentera 06, profilo in pelle Setanil 76, piedi in metallo verniciato colore Champagne finitura Soft Touch.





Chapeau sofa el. SX in leather Natural Velour 50, profilo in leather Setanil 76, Champagne effect painted metal legs, Soft Touch finish. **Jamiro armchair** el. 1 in leather Natural Velour 97, matt black painted metal structure. **Dama coffee tables** el. TP2 in leather Natural Velour 97, top in Travertine stone + el. TG2 in leather Natural Velour 50, top in Travertine stone. **Vogue cuoio bench** el. PAN in leather Setanil 76, black chromed metal legs.

Chapeau divano el. SX in pelle Natural Velour 50, profilo in pelle Setanil 76, piedi in metallo verniciato colore Champagne finitura Soft Touch. **Jamiro poltrona** el. 1 in pelle Natural Velour 97, struttura in metallo verniciato nero. **Dama tavolini** el. TG2 in pelle Natural Velour 50, piano in Travertino. **Vogue cuoio panca** el. PAN in pelle Setanil 76, piedi in metallo cromato nero.



**A STAGING OF LIGHTS AND SHADOWS
THAT FURNISHES PLACES IN CONSTANT
METAMORPHOSIS.**

**GIOCHI DI OMBRE E LUCI CREANO
UNA TRAMA CHE ARREDA GLI SPAZI
IN COSTANTE MUTAMENTO.**

Chapeau sofa el. X in fabric Agamotto 4, profile in leather Natural Velour 77, Champagne effect painted metal legs, Soft Touch finish. **lole armchair** el. 1 in fabric Lario 107, armrests in solid Canaletto walnut wood with Natural Velour 97 woven leather. **Riviera coffee tables** el. TR low, Bronze glass, black painted metal legs RAL 9005 + el. TP high, green glass, black painted metal legs RAL 9005. **Rook bookshelves** el. LI5 in green painted metal RAL 6008, shelves in green lacquered metal RAL 6008.

Chapeau divano el. X in tessuto Agamotto 4, profilo in pelle Natural Velour 77, piedi in metallo verniciato colore Champagne finitura Soft Touch. **lole poltrona** el. 1 in tessuto Lario 107, braccioli in legno massello Noce Canaletto e pelle intrecciata Natural Velour 97. **Riviera tavolini** el. TR basso in vetro bronzo, piedi in metallo verniciato nero RAL 9005 + el. TP alto in vetro verde, piedi in metallo verniciato nero RAL 9005. **Rook librerie** el. LI5 in metallo verniciato verde RAL 6008, piani in legno laccato verde RAL 6008.





Left side **Chapeau** detail Champagne effect painted metal legs Soft Touch finish. Right side **Riviera** black painted metal legs RAL 9005.

A lato sinistro dettaglio piede **Chapeau** verniciato colore Champagne finitura Soft Touch. A lato destro dettaglio piede **Riviera** verniciato nero RAL 9005.



Chapeau sofa el. X in fabric Agamotto 4, profilo in leather Natural Velour 77, Champagne effect painted metal legs, Soft Touch finish. **Iole armchair** el. 1 in fabric Lario 107, armrests in solid Canaletto walnut wood with Natural Velour 97 woven leather. **Riviera coffee tables** el. TR low, bronze glass, black painted metal legs RAL 9005 + el. TP high, green glass, black painted metal legs RAL 9005. **Rook bookshelves** el. LI5 in green painted metal RAL 6008, shelves in green lacquered metal RAL 6008.

Chapeau divano el. X in tessuto Agamotto 4, profilo in pelle Natural Velour 77, piedi in metallo verniciato colore Champagne finitura Soft Touch. **Iole poltrona** el. 1 in tessuto Lario 107, braccioli in legno massello Noce Canaletto e pelle intrecciata Natural Velour 97. **Riviera tavolini** el. TR basso in vetro bronzo, piedi in metallo verniciato nero RAL 9005 + el. TP alto in vetro verde, piedi in metallo verniciato nero RAL 9005. **Rook librerie** el. LI5 in metallo verniciato verde RAL 6008, piani in legno laccato verde RAL 6008.



Chapeau sectional el. 17+20 in leather Nabuk 17, profilo in leather Setanil 80, black painted metal legs. **Jamiro armchair** el. 1 in leather Natural Velour 97, black painted metal frame. **Dama coffee tables** el. TP2 in leather Natural Velour 97, top in solid Canaletto walnut wood + el. TG2 in leather Natural Velour 50, top in solid Canaletto walnut wood + el. TM2 in leather Setanil 42, top in solid Canaletto walnut wood + el. TM2 in leather Setanil 80, top in Travertine stone. **Iceberg coffee tables** el. TP top in marble Breccia Imperiale, polished chromed metal legs.

Chapeau componibile el. 17+20 in pelle Nabuk 17, profilo in pelle Setanil 80, piedi in metallo cromato nero. **Jamiro poltrona** el. 1 in pelle Natural Velour 97, struttura in metallo verniciato nero. **Dama tavolini** el. TP2 in pelle Natural Velour 97, piano in legno massello Noce Canaletto + el. TG2 in pelle Natural Velour 50, piano in legno massello Noce Canaletto + el. TM2 in pelle Setanil 42, piano in legno massello Noce Canaletto + el. TM2 in pelle Setanil 80, piano in Travertino. **Iceberg tavolini** el. TP piano in marmo Breccia Imperiale, piedi in metallo cromato lucido.





NATURE, SENSE AND SENSIBILITY, DIFFERENT LIKE DISTANT PLACES IN THE SAME TERRITORY. THE BOND LINKING THESE WORLDS DRAWS A PLOT OF DIVERSE THREADS JOINED TIGHTLY TOGETHER. LA NATURA, IL SENTIMENTO E LA RAGIONE, DIVERSI COME LUOGHI DISTANTI DI UNO STESSO TERRITORIO. IL LEGAME TRA QUESTI MONDI DISEGNA UN INTRECCIO DI FILI DIVERSI, COSTRUIENDO UNA TRAMA CHE LI CONTIENE E LI UNISCE.

CLIFT IS A COMFORTABLE PLAY OF HEIGHTS AND DEPTHS. AN EXPRESSION OF NATURE, IT SOFTENS ANY STERNNESS OF ITS SURROUNDINGS, DAMPING THEIR EFFECT. CLIFT È UN GIOCO CONFORTEVOLE DI ALTEZZE E PROFONDITÀ. IL SUO POSTO È TRA LE ESPRESSIONI DELLA NATURA, ADDOLCISCE OGNI SEVERITÀ DELL'AMBIENTE, SMORZANDONE L'EFFETTO.

clift

MARCO FUMAGALLI



Clift sofa el. SX in fabric Vellus 14. **Jamiro armchair** el. 1 in leather Natural Velour 97, black painted metal legs. **Dama baskets** el. TM1 in leather Setanil 42 + el. TP1 in leather Natural Velour 97. **Tappo coffee tables** el. TP in leather Natural Velour 50, top in Travertine stone + el. TM in leather Natural Velour 50, top in Travertine stone. **Byron coffee table** el. TO low, in Canaletto walnut wood, smoked finish glass. **Jade console** el. CON in lacquered wood Bordeaux color RAL 3007, polished chromed metal legs.

Clift divano el. SX in tessuto Vellus 14. **Jamiro poltrona** el. 1 in pelle Natural Velour 97, struttura in metallo verniciato nero. **Dama cesti** el. TM1 in pelle Setanil 42 + el. TP1 in pelle Natural Velour 97. **Tappo tavolini** el. TP in pelle Natural Velour 50, piano in Travertino + el. TM in pelle Natural Velour 50, piano in Travertino. **Byron tavolino** el. TO basso in legno Noce Canaletto, piedi in vetro fumè. **Jade consolle** el. CON in legno laccato colore Bordeaux RAL 3007, piedi in metallo cromato lucido.





Clift modular sofa with metal structure and wooden frame. Elastic belts support. Seat cushions in expanded polyurethane foam with three different densities and memory foam covered with acrylic fiber. The backrests and armrests are in metal, covered with expanded polyurethane foam and acrylic fiber. Black plastic legs.

Clift divano modulare con struttura in metallo e telaio in legno. Supporto di nastri elastici. Cuscini di seduta in poliuretano espanso con tre densità differenti e memory foam rivestito con falda acrilica. Schienali e braccioli in metallo rivestiti con poliuretano espanso e falda acrilica. Piedi in polimero nero.



Clift sectional el. 19+37 in leather Cougar 17. **Mac armchairs** el. 1 in fabric Formentera 06, green painted metal frame RAL 6008, black chromed metal final edges. **Byron coffee tables** el. TO low, in Canaletto walnut wood, smoked finish legs + el. TT high in black ash wood, smoked finish legs. **Iceberg coffee tables** el. TM top in marble Cipollino Rosso, metal painted legs Bordeaux RAL 3007 + el. TP top in marble Batik, polished chromed metal legs. **Tappo coffee tables** el. TM in leather Setanil 80, top in Travertine stone.

Clift componibile el. 19+37 in pelle Cougar 17. **Mac poltrone** el. 1 in tessuto Formentera 06, telaio esterno in metallo verniciato opaco colore verde RAL 6008, parti terminali del telaio in metallo cromato nero. **Byron tavolini** el. TO basso in legno Noce Canaletto, piedi in vetro fumè + el. TT alto in legno Frassino nero, piedi in vetro fumè. **Iceberg tavolini** el. TP piano in marmo Batik, piedi in metallo cromato lucido. **Tappo tavolini** el. TM in pelle Setanil 80, piano in Travertino.

Clift sectional el. 19+37 in leather Cougar 17. **Mac armchairs** el. 1 in fabric Formentera 06, green painted metal frame RAL 6008, black chromed metal final edges. **Byron coffee tables** el. TO low, in Canaletto walnut wood, smoked finish legs + el. TT high in black ash wood, smoked finish legs. **Iceberg coffee tables** el. TM top in marble Cipollino Rosso, metal painted legs Bordeaux RAL 3007 + el. TP top in marble Batik, polished chromed metal legs. **Tappo coffee tables** el. TM in leather Setanil 80, top in Travertine stone + el. TG in leather Setanil 80, top in Travertine stone + el. TP in leather Natural Velour 50, top in Travertine stone + el. TX in leather Natural Velour 50, top in Travertine stone.

Clift componibile el. 19+37 in pelle Cougar 17. **Mac poltrone** el. 1 in tessuto Formentera 06, telaio esterno in metallo verniciato opaco colore verde RAL 6008, parti terminali del telaio in metallo cromato nero. **Byron tavolini** el. TO basso in legno Noce Canaletto, piedi in vetro fumè + el. TT alto in legno Frassino nero, piedi in vetro fumè. **Iceberg tavolini** el. TM piano in marmo Cipollino Rosso, piedi in metallo verniciato Bordeaux RAL 3007 + el. TP piano in marmo Batik, piedi in metallo cromato lucido. **Tappo tavolini** el. TM in pelle Setanil 80, piano in Travertino + el. TG in pelle Setanil 80, piano in Travertino + el. TP in pelle Natural Velour 50, piano in Travertino + el. TX in pelle Natural Velour 50, piano in Travertino.





SEASON IS BALANCE, LINEAR SENSATIONS, AND THE STABILITY OF THE SENSES. EACH MODULE IS AN ISLAND OF RELAXATION, EACH COMPOSITION AN INVITE TO CONVIVIALITY AND THE PLEASURE OF COMPANY. SEASON È EQUILIBRIO, LINEARITÀ DELLE SENSAZIONI E STABILITÀ DEI SENSI. OGNI MODULO È UN'ISOLA DI RELAX PER SE STESSI, OGNI COMPOSIZIONE È UN INVITO ALLA CONVIVIALITÀ, AL PIACERE DI STARE CON GLI ALTRI.

season

STEFANO CONFICCONI





Season sectional el. 3LM+C+40+PRT+C+4SM in fabric Floriante 03 + 2x el. CS in fabric Floriante 03 + 2x el. CS in leather Setanil 76. **Season** el. P in fabric Voulez-Vous 003. **Tappo coffee tables** el. TP in leather Setanil 75, top in solid Canaletto walnut wood + el. TM in leather Setanil 10, top in solid Canaletto walnut wood + el. TG in leather Setanil 10, top in solid Canaletto walnut wood. **Vogue cuoio coffee table** el. TT in leather Setanil 80, gloss lacquered black metal legs.

Season componibile el. 3LM+C+40+PRT+C+4SM in tessuto Floriante 03 + 2x el. CS in tessuto Floriante 03 + 2x el. CS in pelle Setanil 76. **Season** el. P in tessuto Voulez-Vous 003. **Tappo tavolini** el. TM in pelle Setanil 10, piano in legno massello Noce Canaletto + el. TG in pelle Setanil 10, piano in legno massello Noce Canaletto. **Vogue cuoio tavolino** el. TT in pelle Setanil 80, piede in metallo verniciato nero lucido.

Season sectional el. 3SM+CM+4SM in leather Nabuk 50 + 2x el. CS in fabric Vellus 14.

Season componibile el. 3SM+CM+4SM in pelle Nabuk 50 + 2x el. CS in tessuto Vellus 14.





Season sectional el. 3LM+C+40+PRT+C+4SM in fabric Floriante 03 + 2x el. CS in fabric Floriante 03 + 2x el. CS in leather Setanil 76. **Season** el. P in fabric Voulez-Vous 003. **Iole armchair** el. 1 in leather Natural Velour 50, armrests in solid White ash wood with Natural Velour 50 woven leather. **Tappo coffee tables** el. TP in leather Setanil 75, top in solid Canaletto walnut wood + el. TM in leather Setanil 10, top in solid Canaletto walnut wood + el. TG in leather Setanil 10, top in solid Canaletto walnut wood. **Vogue cuoio coffee table** el. TT in leather Setanil 80, gloss lacquered black metal legs.

Season componibile el. 3LM+C+40+PRT+C+4SM in tessuto Floriante 03 + 2x el. CS in tessuto Floriante 03 + 2x el. CS in pelle Setanil 76. **Season** el. P in tessuto Voulez-Vous 003. **Iole poltrona** el. 1 in pelle Natural Velour 50, braccioli in legno massello Frassino sbiancato e pelle intrecciata Natural Velour 50. **Tappo tavolini** el. TP in pelle Setanil 75, piano in legno massello Noce Canaletto + el. TM in pelle Setanil 10, piano in legno massello Noce Canaletto + el. TG in pelle Setanil 10, piano in legno massello Noce Canaletto. **Vogue cuoio tavolino** el. TT in pelle Setanil 80, piede in metallo verniciato nero lucido.



UNIQUE LOCATIONS, EACH INDIPENDENT FROM THE
OTHER, ABLE TO EXPRESS THEIR ORIGINAL ESSENCE.
SCENARI UNICI, CIASCUNO INDIPENDENTE DALL'ALTRO,
CAPACI DI ESPRIMERE LA PROPRIA ESSENZA ORIGINALE.

Season sectional el. 3SM+CM+4SM in leather Nabuk 50 + el. CS in fabric Vellus 14. **Jamiro armchair** el. 1 in leather Natural Velour 97, black painted metal frame. **Byron coffee tables** el. TT low, in Canaletto walnut wood, smoked finish legs + el. TQ high in Black ash wood, smoked finish legs.

Season componibile el. 3SM+CM+4SM in pelle Nabuk 50 + el. CS in tessuto Vellus 14. **Jamiro poltrona** el. 1 in pelle Natural Velour 97, struttura in metallo verniciato nero. **Byron tavolini** el. TT basso in legno Noce Canaletto, piedi in vetro fumé + el. TQ alto in legno Frassino nero, piedi in vetro fumé.





Season modular sofa with wooden seat structure and elastic belts, covered with two different densities of expanded polyurethane foam. The model is also available with a mechanism which allows to increase the depth of the seat. The backrest and the armrests are in wood covered with expanded polyurethane foam and acrylic silicon fiber. The feet are in black painted wood.

Season divano modulare con struttura di seduta in legno e supporto di nastri elastici, rivestito in poliuretano espanso in 2 densità differenti. È disponibile anche una versione meccanizzata, che permette l'avanzamento della seduta, aumentandone la profondità. Lo schienale ed i braccioli sono in legno rivestiti in poliuretano espanso ricoperto con fibra acrilica siliconata. I piedi sono in legno verniciato nero.

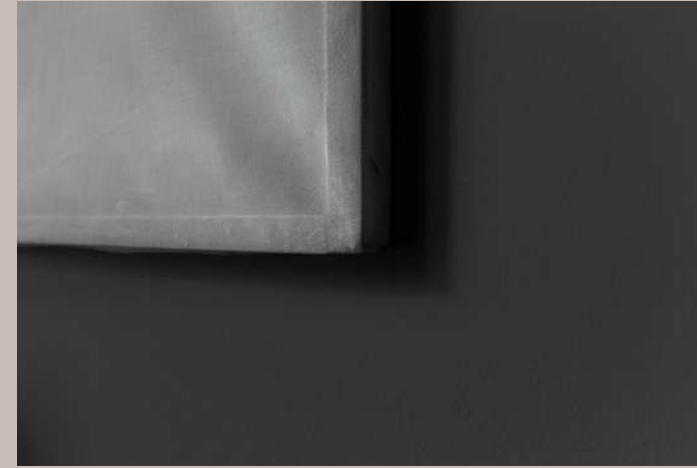

MOTIFS ENDLESSLY REPEATING THEMSELVES,
WEAVES WITH NO FORESEEABLE CLOSURE.
IOLE HOLDS IDEAS, AS THE HAND CARESSES EACH
CARVING ON THE LEATHER, LIKE RIPPLES ON WATER.
MOTIVI CHE SI RIPETONO ALL'INFINITO, INTRECCI
DI CUI NON SI CONOSCE L'ESITO. IOLE OSPITA
I PENSIERI, MENTRE LA MANO SCORRE TRA GLI
INTAGLI DI UNA SUPERFICIE DI PELLE, INCRESPATA
COME LA SUPERFICIE DELL'ACQUA.

iole

MAURIZIO MANZONI





iole armchair el. 1 in fabric Formentera 10 armrests in solid black ash wood with Setanil 10 woven leather.
iole poltrona el. 1 in tessuto Formentera 10, braccioli in legno massello Frassino nero e pelle intrecciata Setanil 10.



Picture above **lole armchair** el. 1 in leather Natural Velour 98, armrests in solid black ash wood with Setanil 10 woven leather. **Picture on right page** armrest **Season** in fabric Floriante 03. **lole armchair** el. 1 in leather Natural Velour 50, armrests in solid white ash wood with Natural Velour 50 woven leather. **Tappo coffee tables** el. TP in leather Setanil 75, top in solid Canaletto walnut wood.

Foto in alto lole poltrona el. 1 in pelle Natural Velour 98, braccioli in legno massello Frassino nero e pelle intrecciata Setanil 10. **Foto pagina destra** dettaglio braccio **Season** in tessuto Floriante 03. **lole poltrona** el. 1 in pelle Natural Velour 50, braccioli in legno massello Frassino sbiancato e pelle intrecciata Natural Velour 50. **Tappo tavolini** el. TP in pelle Setanil 75, piano in legno massello Noce Canaletto.





Iole armchair el. 1 in fabric Lario 107, armrests in solid Canaletto walnut wood, with Natural Velour 97 woven leather.

Iole poltrona el. 1 in tessuto Lario 107, braccioli in legno massello Noce Canaletto e pelle intrecciata Natural Velour 97.



iole armchair el. 1 in fabric Lario 107, armrests in solid Canaletto walnut wood, with Natural Velour 97 woven leather. **Chapeau sofa** el. X in fabric Agamoto 4, profilo in leather Natural Velour 77, Champagne effect painted metal legs, Soft Touch finish. **Rook bookshelves** el. LI5 in green painted metal RAL 6008, shelves in green lacquered metal RAL 6008.

iole poltrona el. 1 in tessuto Lario 107, braccioli in legno massello Noce Canaletto e pelle intrecciata Natural Velour 97. **Chapeau divano** el. X in tessuto Agamoto 4, profilo in pelle Natural Velour 77, piedi in metallo verniciato colore Champagne finitura Soft Touch. **Rook librerie** el. LI5 in metallo verniciato verde RAL 6008, piani in legno laccato verde RAL 6008.



SIMPLE LINES AND COMPLEX DESIGN, FULLNESS AND BEAUTY ARE SHAPED THROUGH EMPTINESS AND ITS FUNCTION. SEMPLICITÀ DI LINEE E COMPLESSITÀ DI PROGETTO, PIENO E BELLEZZA PRENDONO FORMA GRAZIE AL VUOTO E ALLA SUA FUNZIONE.

jamiro
MARCO FUMAGALLI





Picture right page Jamiro armchair el. 1 in leather Natural Velour 97, black painted metal frame. Chapeau sofa el. SX in leather Natural Velour 50, profile in leather Setanil 76, Champagne effect painted metal legs Soft Touch finish. Dama coffee tables el. TP2 in leather Natural Velour 97, top in Travertine stone. Dama baskets el. TM1 in leather Setanil 42. Vogue cuoio bench el. PAN in leather Setanil 76, black chromed metal legs.

Foto pagina destra Jamiro poltrona el. 1 in pelle Natural Velour 97, struttura in metallo verniciato nero. Chapeau divano el. SX in pelle Natural Velour 50, profilo in pelle Setanil 76, piedi in metallo verniciato colore Champagne finitura Soft Touch. Dama tavolini el. TP2 in pelle Natural Velour 97, piano in Travertino. Dama cesti el. TM1 in pelle Setanil 42. Vogue cuoio panca el. PAN in pelle Setanil 76, piedi in metallo cromato nero.



Jamiro armchair el. 1 in leather Setanil 75, black chromed metal legs. Jamiro poltrona el. 1 in pelle Setanil 75, struttura in metallo cromato nero.



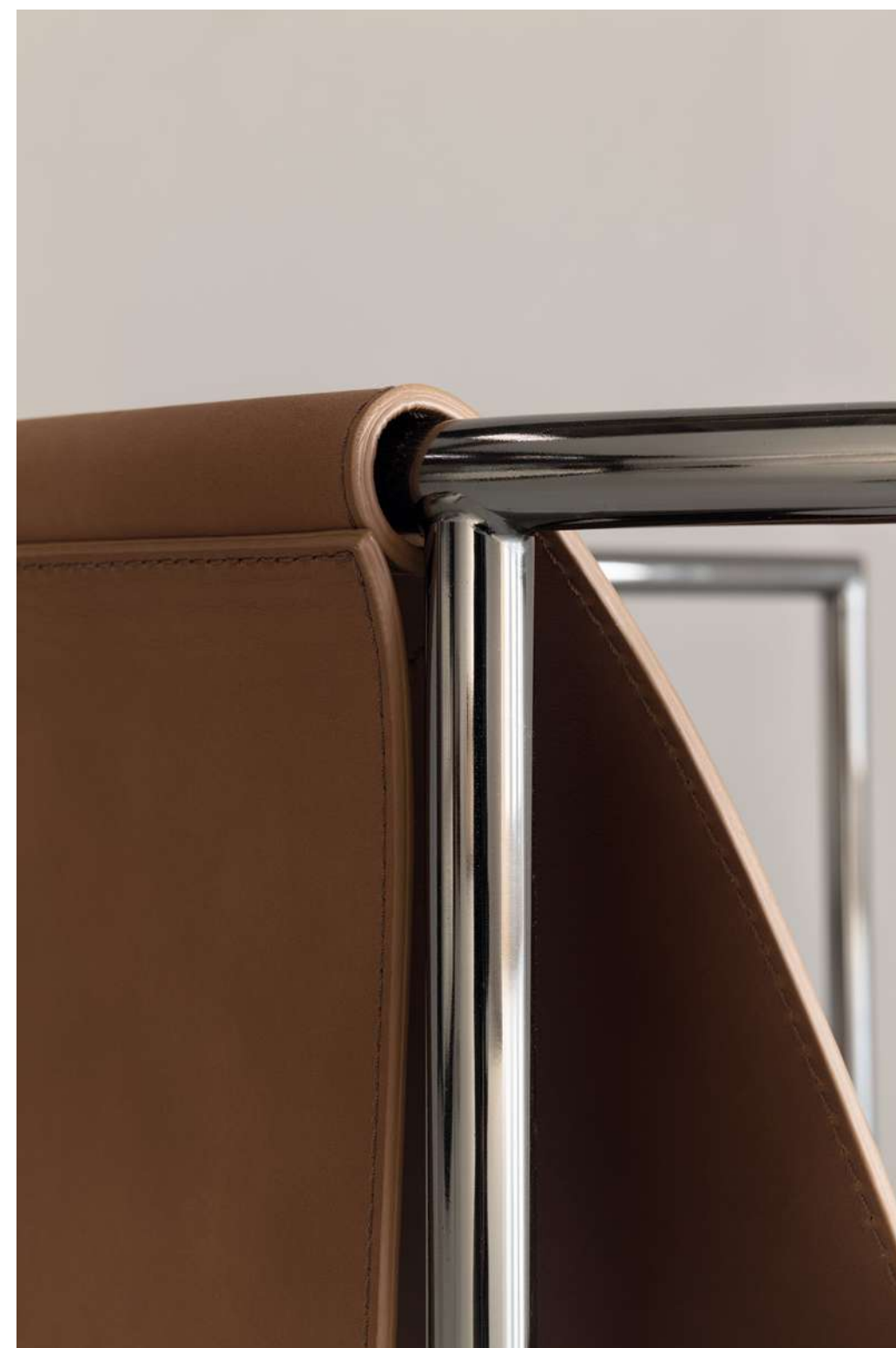

Jamiro armchair el. 1 in leather Natural Velour 97, black painted metal frame. **Tappo coffee tables** el. TM in leather Setanil 80, top in solid Canaletto walnut wood. + el. TP in leather Natural Velour 50, top in Travertine stone. Detail **Jamiro armchair** el. 1 in leather Setanil 75, black chromed metal frame.

Jamiro poltrona el. 1 in pelle Natural Velour 97, struttura in metallo verniciato nero. **Tappo tavolini** el. TM in pelle Setanil 80, piano in legno massello Noce Canaletto + el. TP in pelle Natural Velour 50, piano in Travertino. Dettaglio **Jamiro poltrona** el. 1 in pelle Setanil 75, struttura in metallo cromato nero.

Jamiro armchair with metal structure available in two different finishes: black chromed or matt painted black. The leather seat comes with a "cuoio effect" finishing paired with a high-wearing bonded leather. The seat is available in three different leathers: Soffio, Setanil and Natural Velour. If no preference is specified, the edges feature tone-on-tone lacquering.

Jamiro poltrona con struttura in metallo, disponibile in due diverse finiture: cromato nero o verniciata nera opaca. Seduta in pelle realizzata con una speciale finitura cuoio, disponibile in tre tipologie di pelle: Soffio, Setanil e Natural Velour. I bordi sono verniciati tono su tono se non viene specificata nessuna preferenza.



Woody armchair el.1 in fabric Vellus 1.4, black lacquered metal base RAL 9005. Woody poltrona el.1 in tessuto Vellus 1.4, basamento in legno laccato nero RAL 9005.



woody
MAURIZIO MANZONI

MODERNIST ARCHITECTURE COMES INTO PLAY
AND WOODY BECOMES THE DIRECTOR OF ITS OWN
COMFORT. VA IN SCENA UN'ARCHITETTURA MODERNISTA
E WOODY DIVENTA REGISTA DEL PROPRIO RELAX.



Woody armchair el.1 in fabric Vellus 14, black lacquered wood base RAL 9005. **Dama ottoman** el. TM3 in leather Natural Velour 44, seat in fabric Fjord 05 + el. TG3 in leather Natural Velour 44, seat in fabric Fjord 05. **Rook bookshelf** el. LI5 in white painted metal RAL 9002, shelves in white lacquered metal RAL 9002.

Woody poltrona el.1 in tessuto Vellus 14, basamento in legno laccato nero RAL 9005. **Dama pouf** el. TM3 in pelle Natural Velour 44, seduta in tessuto Fjord 05 + el. TG3 in pelle Natural Velour 44, seduta in tessuto Fjord 05. **Rook libreria** el. LI5 in metallo verniciato bianco RAL 9002, piani in legno laccato bianco RAL 9002.



Woody armchair
el. 1 in leather Ibiza 14, lacquered wooden legs RAL 6008.
Woody poltrona
el. 1 in pelle Ibiza 14, base in legno laccato RAL 6008.



THE POWERFUL BUT DISCREET CHARM OF MINIMALISM.
VOGUE IS THE EXPRESSION OF WHAT LIES WITHIN
EVERY PASSION. IL FASCINO DISCRETO E POTENTE
DELL'ESSENZIALITÀ. VOGUE DESCRIVE L'INTENZIONE
CHE VIVE ALL'INTERNO DI OGNI PASSIONE.

vogue cuoio bed

STEFANO CONFICCONI



Vogue cuoio bed with a metal headboard upholstered with expanded polyurethane foam covered with acrylic silicon fiber. The sommier is made of painted metal with a leather-covered wooden frame with cuoio finish available in three different leathers: Soffio, Setanil and Natural Velour. The metal feet are available in bright chromed or black chromed. If no preference is specified, the edges feature tone-on-tone lacquering. Mattress is not included. Please note: single wooden slat included in the bed.

Voguoie cuoio letto con testiera in metallo imbottita con poliuretano espanso, rivestito con fibra acrilica siliconata. Il sommier è realizzato in metallo verniciato con cornice in legno rivestita in pelle e speciale finitura cuoio, disponibile in 3 tipologie: Soffio, Setanil e Natural Velour. I piedi sono disponibili cromati lucidi o cromati neri. I bordi sono realizzati tono su tono se non viene specificata alcuna preferenza. Il materasso non è incluso. Rete singola a doghe in legno compresa nel letto.



Vogue cuoio bed
el.180 in leather Setanil 76, black chromed metal legs.
Vogue cuoio letto
el.180 in pelle Setanil 76, piedi in metallo cromato nero.



Vogue cuoio bed el. 180 in leather Setanil 76, black chromed metal legs. Headboard in Vellus 14. **Dino bedsides** el. KF in Canaletto walnut wood, drawer handle in Setanil 76, black chromed metal legs. **Vogue cuoio bench** el. PAN base in leather Setanil 76, el. 12C in fabric Vellus 4, black chromed metal legs. **Vogue cuoio coffee table** el. TT in leather Setanil 80, gloss black lacquered metal leg. **Gina armchair** el. 1SB in leather Nabuk 17, black painted metal frame RAL 9005. **Dama coffee tables** el. TP2 in leather Natural Velour 97, top in Travertine stone. **Jared benches** el. PAQ in leather Setanil 76, black painted metal legs Soft Touch finish.

Vogue cuoio letto el. 180 in pelle Setanil 76, piedi in metallo cromato nero. Testiera in Vellus 14. **Dino comodini** el. KF in legno Noce Canaletto, maniglia cassetto in Setanil 76, piedi in metallo cromato nero. **Vogue cuoio panca** el. PAN base in pelle Setanil 76, el. 12C in tessuto Vellus 4, piedi in metallo cromato nero. **Vogue cuoio tavolino** el. TT in pelle Setanil 80, piede in metallo verniciato nero lucido. **Gina poltrona** el. 1SB in pelle Nabuk 17, tubolare metallico verniciato nero RAL 9005. **Dama tavolini** el. TP2 in pelle Natural Velour 97, piano in Travertino. **Jared panche** el. PAQ in pelle Setanil 76, struttura in metallo verniciato colore nero finitura Soft Touch.



“NOT HE WHO BEGINS, BUT HE WHO PERSEVERES”
“NON CHI COMINCIA, MA QUEL CHE PERSEVERA”

LEONARDO DA VINCI



JARED IS ARTISANAL BEAUTY AND MODERN VISION, A RATIONAL SURFACE IMMERSSED IN A HÁND-WOVEN LEATHER BACKDROP. JARED E BELLEZZA ARTIGIANALE E VISIONE MODERNA INSIEME, UNA SUPERFICIE RAZIONALE IMMERSA IN UNO SFONDO DI PELLE INTRECCIATA A MANO.

jared bed
MAURIZIO MANZONI



Jared bed el.180 sommier in fabric Floriante 03, headboard in Setanil 75 woven leather, black painted metal headboard and legs Soft Touch finish. **Alfi coffee tables** el. CV2 in black ash wood, green painted metal frame RAL 6008. **Jamiro armchair** el. 1 in leather Setanil 75, black chromed metal frame. **Dama baskets** el. TG1 in leather Natural Velour 77. **Tappo coffee tables** el. TP2 in leather Natural Velour 50, top in Travertine stone. **Rook bookshelves** el. LI5 in black painted metal RAL 9005, shelves in black lacquered metal RAL 9005.

Jared letto el.180 sommier in tessuto Floriante 03, testiera intrecciata in pelle Setanil 75, struttura testiera e piedi in metallo verniciati colore nero finitura Soft Touch. **Alfi tavolini** el. CV2 in legno Frassino nero, basamento tubolare verniciato verde RAL 6008. **Jamiro poltrona** el. 1 in pelle Setanil 75, struttura in metallo cromato nero. **Dama cesti** el. TG1 in pelle Natural Velour 77. **Tappo tavolini** el. TP2 in pelle Natural Velour 50, piano in Travertino. **Rook libreria** el. LI5 in metallo verniciato nero RAL 9005, piani in legno laccato nero RAL 9005.

Jared bed black painted metal headboard Soft Touch finish, Setanil 75 woven leather. **Jared letto** testiera verniciata nero finitura Soft Touch, pelle intrecciata in Setanil 75.





Jared bed el.180 sommier in fabric Floriante 03, headboard in Setanil 75 woven leather, black painted metal headboard and legs Soft Touch finish. **Alfi coffee tables** el. CV2 in black ash wood, green painted metal frame RAL 6008. **Dama baskets** el. TG1 in leather Natural Velour 77. **Tappo coffee tables** el. TP2 in leather Natural Velour 50, top in Travertine stone. **Rook bookshelves** el. LI5 in black painted metal RAL 9005, shelves in black lacquered metal RAL 9005.

Jared letto el.180 sommier in tessuto Floriante 03, testiera intrecciata in pelle Setanil 75, struttura testiera e piedi in metallo verniciati colore nero finitura Soft Touch. **Alfi tavolini** el. CV2 in legno Frassino nero, basamento tubolare verniciato verde RAL 6008. **Dama cesti** el. TG1 in pelle Natural Velour 77. **Tappo tavolini** el. TP in pelle Natural Velour 50, piano in Travertino. **Rook librerie** el. LI5 in metallo verniciato nero RAL 9005, piani in legno laccato nero RAL 9005.

Jared bed with painted metal headboard available in two colors: Champagne and black. The headboard is decorated with woven leather with special raw cut edges finishing, available in three different leathers: Soffio, Setanil and Natural Velour. The standard finishing of headboard back-side, is made of black Romana leather, it is possible to have it in the same leather as the front with an up-charge. The wooden frame is covered with expanded polyurethane foam further covered with acrylic fiber. The metal feet are painted Champagne or black. If no preference is specified, the edges feature tone-on-tone lacquering. The mattress is not included.

Jared letto con testiera in metallo verniciato disponibile in due colori: Champagne e nero. Testata decorata con intreccio pelle accoppiata con finitura cuoio, disponibile in 3 tipologie di pelle: Soffio, Setanil e Natural Velour. Il retro della testata standard è realizzato in pelle Romana nero, è possibile averlo nella stessa pelle del fronte con un supplemento. Sommier in legno ricoperto con poliuretano espanso, rivestito con fibra acrilica. Piedi in metallo verniciato color Champagne o nero. I bordi sono realizzati tono su tono se non viene specificata alcuna preferenza. Il materasso non è incluso.



Jared bed el. 180 in leather Natural Velour 50, Champagne effect painted headboard frame and metal legs Soft Touch finish. **Jared benches** el. PAN in leather Natural Valour 50, Champagne effect painted metal frame Soft Touch finish. **Tappo coffee tables** el. TG in leather Soffio 50, top in solid Canaletto walnut wood + el. TM in leather Soffio 17, top in solid Canaletto walnut wood. **Lip chest** el. M3C Canaletto walnut wood, top detail in Travertine stone, black chromed metal legs.

Jared letto el. 180 in pelle Natural Velour 50, struttura testiera e piedi in metallo verniciati colore Champagne finitura Soft Touch. **Jared panche** el. PAN in pelle Natural Valour 50, struttura in metallo verniciato colore Champagne finitura Soft Touch. **Tappo tavolini** el. TG in pelle Soffio 50, piano in legno massello Noce Canaletto + el. TM in pelle Soffio 17, piano in legno massello Noce Canaletto. **Lip cassetiera** el. M3C in legno Noce Canaletto, dettaglio del top in Travertino, piedi in metallo cromato nero.





Jared bed
el. 180 in leather Natural Velour 50, Champagne effect painted headboard frame and metal legs Soft Touch finish.

Jared letto
el. 180 in pelle Natural Velour 50, struttura testiera e piedi in metallo verniciati colore Champagne finitura Soft Touch.



LIP REPRESENTS GENEROUS VOLUME, A PICTURE OF SOLID REFINEMENT WHOSE ROUNDNESS REDEFINES THE PROPORTIONS OF ITS SURROUNDINGS, BESTOWING SOPHISTICATED VOLUPTUOUSNESS. LIP RAPPRESENTA UN VOLUME GENEROSO, UN'IMMAGINE DI SOLIDA RAFFINATEZZA CHE, ATTRAVERSO LE ROTONDITÀ, RIDEFINISCE LE PROPORZIONI DI UN AMBIENTE CONFERENDOGLI UNA SOFISTICATA VOLUTTA.

lip

MARCO FUMAGALLI





Lip sideboard
detail el. CZ in Canaletto walnut wood, top in Travertine stone.
Lip madia
dettaglio el. CZ in legno Noce Canaletto, top in Travertino.



Left. **Lip sideboard** el. CZ in Canaletto walnut wood, top detail in Travertine stone, black chromed metal legs. Right. **Lip sideboard** el. CZ in green lacquered wood RAL 6008, top detail in Travertine stone, black chromed metal legs.

Sinistra. **Lip madia** el. CZ in legno Noce Canaletto, dettaglio del top in Travertino, piedi in metallo cromato nero. Destra. **Lip madia** el. CZ in legno laccato colore verde RAL 6008, dettaglio del top in Travertino, piedi in metallo cromato nero.





Lip chest el. M3C Canaletto walnut wood, top detail in Travertine stone, black chromed metal legs.
Lip cassetiera el. M3C in legno Noce Canaletto, dettaglio del top in Travertino, piedi in metallo cromato nero.

COMPOSITIONAL FREEDOM. TIMELESS ELEGANCE. IN WOOD OR LACQUERED FINISH FOR A MORE MODERN EFFECT. THE METAL STRUCTURE SUSTAINS AND UPLIFTS THE FLY CUPBOARD FOR A RESULT OF TRANSPARENT LIGHTNESS. **LIBERTÀ COMPOSITIVA. ELEGANTE E SENZA TEMPO. IN ESSENZA OPPURE LACCATA PER UN EFFETTO PIÙ MODERNO. LA STRUTTURA PORTANTE COMPLETAMENTE IN METALLO SORREGGE LA MADIA FLY, STACCANDOLA DA TERRA, PER UN RISULTATO DI TRASPARENTE LEGGEREZZA.**

fly

MAURIZIO MANZONI

Fly sideboard el. MAX wooden frame light Lati finish, Bronze glass, black painted metal basement RAL 9005. **Jared benches** el. PAN in leather Natural Velour 50, Champagne effect painted metal frame Soft Touch finish + el. PAQ in leather Natural Velour 50, Champagne effect painted metal frame Soft Touch finish. **Tappo coffee tables** el. TP in leather Natural Velour 50, top in Travertine stone + el. TX in leather Natural Velour 50, top in Travertine stone.

Fly madia el. MAX struttura in legno finitura Lati chiaro, bussolotti di vetro colore bronzo, basamento di metallo verniciato nero RAL 9005. **Jared panche** el. PAN in pelle Natural Velour 50, struttura in metallo verniciato colore Champagne finitura Soft Touch + el. PAQ in pelle Natural Velour 50, struttura in metallo verniciato colore Champagne finitura Soft Touch. **Tappo tavolini** el. TP in pelle Natural Velour 50, piano in Travertino + el. TX in pelle Natural Velour 50, piano in Travertino.





Fly sideboard el. MAX in black ash wood, bronze tinted glass, lacquered metal legs RAL 9005. **Riviera coffee table** TT in bronze tinted glass, lacquered metal legs RAL 9005.
Fly madia el. MAX in frassino nero, vetro bronzato, piedi in metallo verniciato RAL 9005. **Riviera tavolino** TT in vetro bronzato, piedi in metallo verniciato RAL 9005.

GIVING THE ILLUSION OF TRICKLES OF WATER ON A SEA SHORE, THE ROUND LEGS CREATE AN IMAGINARY PROFILE THAT RISES FROM THE GROUND, GIVING FIRMNESS TO THE STRUCTURE. SEMBRA UN RIVOLO D'ACQUA SULLA SPONDA DI UN TERRITORIO MARINO. I PIEDI STONDATI FORMANO UN PROFILO IMMAGINARIO CHE SI ALZA DAL PAVIMENTO E REGALANO ROBUSTEZZA ALLA STRUTTURA.

riviera

MARCO FUMAGALLI



Riviera dining table el. X25 top in green tempered glass, black painted metal legs RAL 9005. **Giorgio chairs** el. S in leather Nabuk 98, green painted metal frame RAL 6008.

Riviera tavolo el. X25 piano in vetro in fusione colore verde, piedi in metallo verniciati nero RAL 9005. **Giorgio sedie** el. S in pelle Nabuk 98, tubolare metallico verniciato colore verde RAL 6008.



Riviera dining table el. X25 top in green tempered glass, black painted metal legs RAL 9005.

Riviera tavolo el. X25 dettaglio piano in vetro in fusione colore verde, piedi in metallo verniciato nero RAL 9005.

Riviera dining table and **coffee tables** glass top details: green, blue and bronze.

Riviera tavolo e tavolini dettagli dei piani in vetro: verde, blu e bronzato.





Riviera dining table el. X25 top in Black ash wood, black painted metal legs RAL 9005. **Mac chairs** el. S in leather Ibiza 10, black matte painted metal frame RAL 9005, polished chromed final edges.
Riviera tavolo el. X25 in legno Frassino nero, piedi in metallo verniciato nero RAL 9005. **Mac sedie** el. S in pelle Ibiza 10, struttura metallica verniciato opaco RAL 9005, terminali cromati.

ESSENTIAL AND GENEROUS, ZED IS THE DESK
THAT WILL WELCOME YOUR THOUGHTS EVERY NIGHT.
COSÌ ESSENZIALE E GENEROSO, ZED È LO SCRITTOIO
CHE OGNI SERA ACCOGLIE I PENSIERI.

zed

MARCO FUMAGALLI

Zed desk el. Z16 - top in leather Setanil 76 top in Canaletto walnut wood, legs in leather Setanil 76, black chromed metal legs detail. **Adele chair** el. S in leather Natural Velour 14, painted external metal frame Bordeaux RAL 3007. **Tappo coffee tables** el. TM in leather Setanil 80, top in solid Canaletto walnut wood. **Clift sectional** el. 19+37 in leather Cougar 17. **Mac armchair** el. 1 in fabric Formentera 06, green painted metal frame RAL 6008, black chromed metal final edges. **Byron coffee tables** el. TO low, in Canaletto walnut wood, smoked finish legs + el. TT high in Black ash wood, smoked finish legs.

Zed scrivania el. Z16 - piano in pelle Setanil 76 con top in legno Noce Canaletto, piedi in pelle Setanil 76, profilo piedi in metallo cromato nero. **Adele sedia** el. S in pelle Natural Velour 14, telaio esterno in metallo verniciato Bordeaux RAL 3007. **Tappo tavolini** el. TM in pelle Setanil 80, piano in legno massello Noce Canaletto. **Clift componibile** el. 19+37 in pelle Cougar 17. **Mac poltrona** el. 1 in tessuto Formentera 06, telaio esterno in metallo verniciato opaco colore verde RAL 6008, parti terminali del telaio in metallo cromato nero. **Byron tavolini** el. TO basso in legno Noce Canaletto, piedi in vetro fumé + el. TT alto in legno Frassino nero, piedi in vetro fumé.

Zed desk
detail in leather Setanil 76, top in Canaletto walnut wood.
Zed scrivania
dettaglio piano in pelle Setanil 76, top in legno Noce Canaletto.



Zed desk el. Z16 top in leather Setanil 76 top in Canaletto walnut wood, legs in leather Setanil 76, black chromed metal legs detail. **Adele chair** el. S in leather Natural Velour 14, painted external metal frame Bordeaux RAL 3007.
Zed scrivania el. Z16 piano in pelle Setanil 76, top in legno Noce Canaletto, piedi in pelle Setanil 76, profilo piedi in metallo cromato nero. **Adele sedia** el. S in pelle Natural Velour 14, telaio esterno in metallo verniciato Bordeaux RAL 3007.

ELEGANCE WITH NO EDGES, GEOMETRY
WITH NO EXCESSES. SHAPES AND FORMS
TO COMBINE AND INVENT. BYRON DECORATES
WITHOUT SHOWING OFF, PERSUASIVE IN ITS
INEHERENT SOBRIETY. ELEGANZA SENZA
SPIGOLI, GEOMETRIA SENZA ECCESSI E
SOPRATTUTTO FORME, FIGURE DA COMPORRE
ED INVENTARE. BYRON ARREDA SENZA
APPARIRE, CONVINCE CON LA SUA INNATA
SOBRIETA'.

byron

MARCO FUMAGALLI





Byron coffee tables el. TO low, in Canaletto walnut wood, smoked finish legs + el. TT high in Black ash wood, smoked finish legs + el. TT low in Canaletto walnut wood, smoked finish legs + el. TQ high in Black ash wood, smoked finish legs.

Byron tavolini el. TO basso in legno Noce Canaletto, piedi in vetro fumè + el. TT alto in legno Frassino nero, piedi in vetro fumè + el. TT basso in legno Noce Canaletto, piedi in vetro fumè + el. TQ alto in legno Frassino nero, piedi in vetro fumè.



Byron coffee tables el. TT low in Canaletto walnut wood, smoked finish legs + el. TQ high in Black ash wood, smoked finish legs. **Season sectional** el. 3SM+CM+4SM in leather Nabuk 50.

Byron tavolini el. TT basso in legno Noce Canaletto, piedi in vetro fumè + el. TQ alto in legno Frassino nero, piedi in vetro fumè. **Season componibile** el. 3SM+CM+4SM in pelle Nabuk 50.



Clift sofa el. SX in fabric Vellus 14. **Dama baskets** el. TM1 in leather Setanil 42 + el. TP1 in leather Natural Velour 97. **Tappo coffee tables** el. TP in leather Natural Velour 50, top in Travertine stone + el. TM in Natural Velour 50, top in Travertine stone. **Byron coffee table** el. TO low, in Canaletto walnut wood, smoked finish legs.

Clift divano el. SX in tessuto Vellus 14. **Dama cesti** el. TM1 in pelle Setanil 42 + El. TP1 in pelle Natural Velour 97. **Tappo tavolini** el. TP in pelle Natural Velour 50, piano in travertino + el. TM in pelle Natural Velour 50, piano in travertino. **Byron tavolino** el. TO basso in legno Noce Canaletto, piedi in vetro fumè.



Byron coffee tables with veneered wood top in two finishes: Canaletto walnut wood and black ash. Glass feet available in two finishes: extra clear and smoked.

Byron tavolini con top in legno impiallacciato con due finiture: Noce Canaletto e frassino nero. Piedi in vetro disponibile in due finiture: extra chiaro e fumè.



A CIRCLE OF MARBLE OR WOOD, SUSTAINED BY AN ESSENTIAL STRIP OF LEATHER, ITS PLACE IS ANYWHERE WE DESIRE, ITS TIME IS NOW AND FOREVER. UN CERCHIO DI MARMO O DI MASSELLO, SOSTENUTO DA UNA ESSENZIALE DIRETTRICE DI CUIOIO, E IL SUO POSTO È OVUNQUE VOGLIAMO CHE SIA, IL SUO TEMPO È ADESSO E PER SEMPRE.

tappo
CIERRE LAB



Tappo coffee tables el. TM in leather Setanil 80, top in solid Canaletto walnut wood + el. TP in leather Setanil 75, top in solid Canaletto walnut wood + el. TG in leather Setanil 75, top in solid Canaletto walnut wood + el. TX in leather Natural Velour 50, top in solid Canaletto walnut wood.

Tappo tavolini el. TM in pelle Setanil 80, piano in legno massello Noce Canaletto + el. TP in pelle Setanil 75, piano in legno massello Noce Canaletto + el. TG in pelle Setanil 75, piano in legno massello Noce Canaletto + el. TX in pelle Natural Velour 50, piano in legno massello Noce Canaletto.



Tappo coffee tables el. TX in leather Natural Velour 50, top in Travertine stone + el. TM in leather Setanil 80, top in Travertine stone + el. TG in leather Setanil 80, top in Travertine stone + el. TP in leather Natural Velour 50, top in Travertine stone. **Fly sideboard** el. MAX wooden frame light Lati finish, Bronze glass, black painted metal basement RAL 9005.

Tappo tavolini el. TX in pelle Natural Velour 50, piano in Travertino + el. TM in pelle Setanil 80, piano in Travertino + el. TG in pelle Setanil 80, piano in Travertino + el. TP in pelle Natural Velour 50, piano in Travertino. **Fly madia** el. MAX struttura in legno finitura Lati chiaro, bussolotti di vetro colore bronzo, basamento di metallo verniciato nero RAL 9005.



Tappo coffee tables el. TX in leather Natural Velour 50, top in Travertine stone + el. TM in leather Setanil 80, top in Travertine stone + el. TG in leather Setanil 80, top in Travertine stone + el. TP in leather Natural Velour 50, top in Travertine stone. **Mac armchair** el. 1 in fabric Formentera 06, green painted metal frame RAL 6008, black chromed metal final edges.

Tappo tavolini el. TX in pelle Natural Velour 50, piano in Travertino + el. TM in pelle Setanil 80, piano in Travertino + el. TG in pelle Setanil 80, piano in Travertino + el. TP in pelle Natural Velour 50, piano in Travertino. **Mac poltrona** el. 1 in tessuto Formentera 06, telaio esterno in metallo verniciato opaco colore verde RAL 6008, parti terminali del telaio in metallo cromato nero.





Tappo coffee tables with top in Travertine stone or solid Canaletto walnut wood. Wooden base painted black. Structure in high-wearing plastic covered in leather with special raw cut edges finishing, available in three different leathers: Soffio, Setanil and Natural Velour. If no preference is specified, the edges feature tone-on-tone lacquering.

Tappo tavolini con top in Travertino o legno massello Noce Canaletto. Struttura base in legno verniciato nero. Struttura corpo polimero ad alta resistenza, rivestito in pelle con finitura cuoio disponibile in tre tipologie di pelle: Soffio, Setanil, Natural Velour. I bordi sono realizzati tono su tono se non viene specificata alcuna preferenza.



Tappo coffee tables detail Cuoio effect. Tappo tavolini dettaglio finitura Cuoio laterale.

THROUGH BRONZE REFLECTIONS THE EYE CAN CATCH GLIMPSES OF AN INGENIOUS HELIX-SHAPED STRUCTURE. HELIX IS A DYNAMIC CONCEPT PRODUCING A STATIC FUNCTION, IT'S STILL MOVEMENT, IT'S ROTATION IN PROGRESS. RIFLESSI DI BRONZO LASCIANO INTRAVEDERE UNA INGEGNOSA STRUTTURA AD ELICA. HELIX È UN CONCETTO DINAMICO CHE PRODUCE UNA FUNZIONE STATICA, E MOVIMENTO FERMO, E ROTAZIONE IN DIVENIRE.

helix

MAURIZIO MANZONI





Helix coffee tables el. TBT in leather Setanil 76, bronze glass top, black chromed metal base. **Tappo coffee tables** el. TM in leather Setanil 80, top in solid Canaletto walnut wood.

Helix tavolini el. TBT in pelle Setanil 76, piano in vetro colore bronzo, basamento inferiore in metallo cromato nero. **Tappo tavolini** el. TM in pelle Setanil 80, piano in legno massello Noce Canaletto.

Helix coffee tables with glass top available in two finishes: extra clear and bronze. Metal base covered in leather with special raw cut edges finishing, available in three different leathers: Soffio, Setanil and Natural Velour. If no preference is specified, the edges feature tone-on-tone lacquering. Metal support plate available in bright chromed or black chromed finish.

Helix tavolini con top in vetro disponibile in due colori: extra chiaro e bronzo. Basamento in metallo rivestito in pelle con finitura cuoio, disponibile in tre tipologie di pelle: Soffio, Setanil, Natural Velour. I bordi sono realizzati tono su tono se non viene specificata alcuna preferenza. Piastra di appoggio in metallo disponibile cromata lucida o cromata nera.



Helix coffee tables el. TAT + el. TBT in leather Setanil 76, extra clear top, black chromed metal base.

Helix tavolini el. TAT + el. TBT in pelle Setanil 76, piano in vetro extra chiaro, basamento inferiore in metallo cromato nero.



GENEROUS COUNTERTOP BY DAY, DISCREET PRESENCE BY NIGHT.
DINO IS HERE, ITS SPONTANEOUS GRACE DECORATES THE BEDROOM
WITH SOBER ELEGANCE. **GENEROSO PIANO D'APPOGGIO DI GIORNO,
PRESENZA DISCRETA LA NOTTE. DINO C'E, LA SUA GRAZIA SPONTANEA
ORNA LA STANZA DA LETTO DI SOBRIA ELEGANZA.**

dino

MARCO FUMAGALLI





Dino drawer with soft-closing mechanism available in Canaletto walnut wood. Leather handle in Setanil 76. Metal base available in bright chromed or black chromed finish.

Dino cassetto con soft closing disponibile in finitura noce Canaletto. Maniglia in pelle Setanil 76. Base in metallo disponibile cromata lucida o cromata nera.

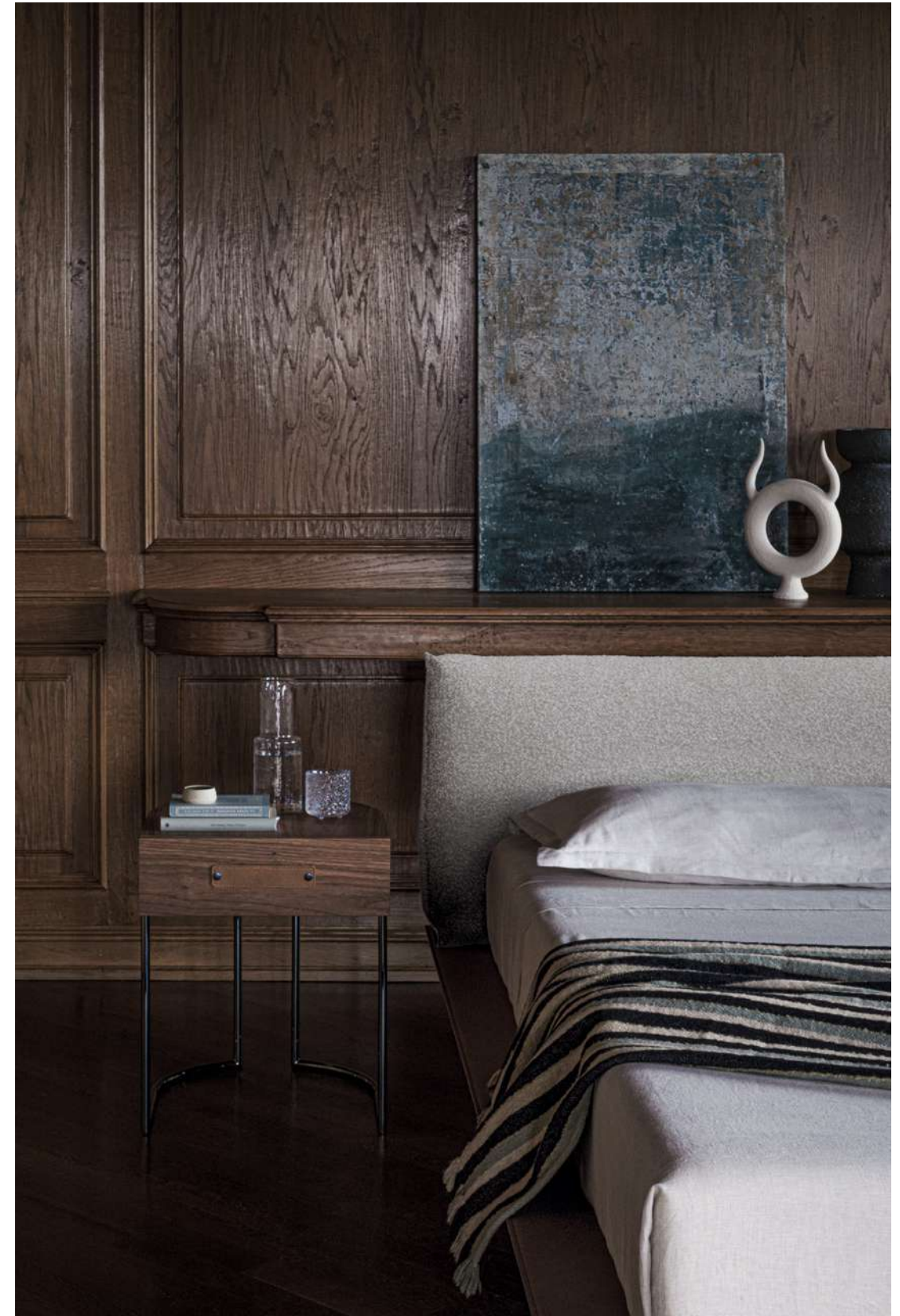

Dino bedside el. KF in Canaletto walnut wood, drawer handle in leather Setanil 76, black chromed metal legs. **Vogue cuoio bed** el.180 in leather Setanil 76, headboard in Vellus 14, black chromed metal legs.

Dino comodini el. KF in legno Noce Canaletto, maniglia cassetto in pelle Setanil 76, piedi in metallo cromato nero. **Vogue cuoio letto** el.180 in pelle Setanil 76, testiera Vellus 14, piedi in metallo cromato nero.

**EACH CHESS PIECE HAS ITS FUNCTION,
AND DAMA CHANGES SHAPES TO PLAY
A DIFFERENT ROLE EVERY TIME.
OGNI PEZZO SULLA SCACCHIERA
HA LA SUA FUNZIONE E DAMA CAMBIA
FORMA PER ASSUMERE FUNZIONI DIVERSE.**

dama

MAURIZIO MANZONI

Dama basket el. TP1 in leather Natural Velour 97. **Dama ottoman** el. TM3 + el. TG3 in leather Natural Velour 44, seat in fabric Fjord 05, el. TM3 in leather Natural Velour 77, seat in fabric Formentera 10, el. TG3 in leather Natural Velour 77, seat in fabric Formentera 10.

Dama cesto el. TP1 in pelle Natural Velour 97. **Dama pouf** el. TM3 el. TG3 in pelle Natural Velour 44, seduta in tessuto Fjord 05, el. TM3 in pelle Natural Velour 77, seduta in tessuto Formentera 10, el. TG3 in pelle Natural Velour 77, seduta in tessuto Formentera 10.



**DAMA CAN BE A FOOT-STOOL,
A RUDIMENTARY SEAT, BEAUTIFUL
AND TIMELESS. DAMA PUÒ ESSERE POUF,
SEDUTA PRIMITIVA, BELLA ED ESTEMPORANEA.**

dama

OTTOMAN
POUF

Dama seat upholstered with expanded polyurethane foam with two different densities covered with acrylic fiber. Woven leather structure with special raw cut edges finish available in three different leathers: Soffio, Setanil and Natural Velour. If no preference is specified, the edges feature tone-on-tone lacquering. The base is made of painted black wood.

Dama seduta in poliuretano espanso con 2 densità rivestite con falda acrilica. Struttura in pelle intrecciata finitura cuoio, disponibile in tre tipologie di pelle: Soffio, Setanil e Natural Velour. I bordi sono realizzati tono su tono se non viene specificata alcuna preferenza. Base in legno verniciata nera.



Dama ottoman el. TM3 + el. TG3 in leather Natural Velour 44, seat in fabric Fjord 05. **Rook bookshelf** el. LI5 in white painted metal RAL 9002, shelves in white lacquered metal RAL 9002.
Dama pouf el. TM3 + el. TG3 in pelle Natural Velour 44, seduta in tessuto Fjord 05. **Rook libreria** el. LI5 in metallo verniciato bianco RAL 9002, piani in legno laccato bianco RAL 9002.

**DAMA CAN BE A WOVEN-LEATHER TABLE,
CONTRASTING WITH ANY BACKDROP.
DAMA PUÒ ESSERE TAVOLINO DI PELLE
INTRECCIATA E DARE UN CONTRASTO
A OGNI SFONDO.**

dama

COFFEE TABLES
TAVOLINI

Dama coffee tables el. TP2 in leather Natural Velour 97, top in solid Canaletto walnut wood + el. TG2 in leather Natural Velour 50, top in solid Canaletto walnut wood + el. TM2 in leather Setanil 80, top in solid Canaletto walnut wood.
Dama tavolini el. TP2 in pelle Natural Velour 97, piano in legno massello Noce Canaletto + el. TG2 in pelle Natural Velour 50, piano in legno massello Noce Canaletto + el. TM2 in pelle Setanil 80, piano in legno massello Noce Canaletto.





Dama coffee tables with removable container top in two finishes: Travertine stone and solid Canaletto walnut wood. The wooden base is painted black. The support metal structure is painted black, the external structure is made of woven leather with special raw cut edges finishing available in three different leathers: Soffio, Setanil and Natural Velour. If no preference is specified, the edges feature tone-on-tone lacquering.

Dama tavolini con top removibile per contenitore in due finiture: Travertino e legno massello Noce Canaletto. Base in legno verniciata nera. Struttura di sostegno in metallo verniciato nero, struttura esterna in pelle intrecciata finitura cuoio disponibile in tre tipologie di pelle: Soffio, Setanil e Natural Velour. I bordi sono realizzati a tono su tono se non viene specificata alcuna preferenza.

Dama coffee tables el. TP2 in leather Natural Velour 97, top in Travertine stone + el. TG2 in leather Natural Velour 50. **Vogue cuoio coffee table** el. TT in leather Setanil 80, gloss lacquered black metal legs. **Gina armchair** el. 1SB in leather Nabuk 17, black painted metal frame RAL 9005. **Jared benches** el. PAQ in leather Setanil 76, black painted metal legs Soft Touch finish.

Dama tavolini el. TP2 in pelle Natural Velour 97, piano in Travertino + el. TG2 in pelle Natural Velour 50, piano in Travertino + el. TM2 in pelle Setanil 42, piano in Travertino. **Vogue cuoio tavolino** el. TT in pelle Setanil 80, piede in metallo verniciato nero lucido. **Gina poltrona** el. 1SB in pelle Nabuk 17, tubolare metallico verniciato nero RAL 9005. **Jared panche** el. PAQ in pelle Setanil 76, struttura in metallo verniciato colore nero finitura Soft Touch.



DAMA CAN BE A CONTAINER OF OBJECTS,
FLOWER VASE. OR SIMPLY A COLLECTOR
OF IDEAS. DAMA PUÒ ESSERE CONTENITORE
DI COSE, VASO DI FIORI, OPPURE SOLTANTO
UN RACCOGLITORE DI IDEE.

dama

BASKETS
CESTI





Damia container with black painted wooden base. Woven leather structure with special raw cut edges finishing available in three different leathers: Soffio, Setanil and Natural Velour. If no preference is specified, the edges feature tone-on-tone lacquering.

Damia contenitore con base in legno verniciata nera. Struttura in pelle intrecciata con finitura cuoio disponibile in tre tipologie di pelle: Soffio, Setanil e Natural Velour. I bordi sono realizzati tono su tono se non viene specificata alcuna preferenza.



Damia baskets el. TM1 in leather Setanil 42 + el. TP1 in leather Natural Velour 97 + el. TG1 in leather Natural Velour 77. **Tappo coffee tables** el. TP in leather Setanil 75, top in solid Canaletto walnut wood + el. TP in leather Natural Velour 50, top in Travertine stone.

Damia cesti el. TM1 in pelle Setanil 42 + el. TP1 in pelle Natural Velour 97 + el. TG1 in pelle Natural Velour 77. **Tappo tavolini** el. TP in pelle Setanil 75, piano in legno massello Noce Canaletto + el. TP in pelle Natural Velour 50, piano in Travertino.

**THIN LINES OVER STRONG STRUCTURES,
WOVEN LEATHER SEATS EVOKING BEAUTIFUL
SUNNY SEASONS. LINEE ESILI SU STRUTTURE
FORTI, SEDUTE IN PELLE INTRECCIATA CHE
EVOCANO BELLE STAGIONI ASSOLATE.**

jared bench

MAURIZIO MANZONI

Jared bench el. PAN in leather Natural Velour 50,
Champagne effect painted metal frame Soft Touch finish.
Jared panca el. PAN in pelle Natural Velour 50, struttura in
metallo verniciato colore Champagne finitura Soft Touch.



Jared bench el. PAN in leather Natural Valour 50, Champagne effect painted metal frame Soft Touch finish + el. PAQ in leather Setanil 75, black painted metal legs Soft Touch finish.

Jared panca el. PAN in pelle Natural Velour 50, struttura in metallo verniciato colore Champagne finitura Soft Touch + el. PAQ in pelle Setanil 75, struttura in metallo verniciato colore nero finitura Soft Touch.



Jared bench el. PAQ detail in leather Setanil 75, black painted metal legs Soft Touch finish.

Jared panca el. PAQ dettaglio in pelle Setanil 75, struttura in metallo verniciato colore nero finitura Soft Touch.

Jared bench painted metal structure available in two colors: Champagne and black. Seat made of woven leather with special raw cut edges finish available in three different leathers: Soffio, Setanil and Natural Velour. If no preference is specified, the edges feature tone-on-tone lacquering.

Jared panca struttura in metallo verniciata disponibile in due colori: Champagne e nero. Seduta in pelle intrecciata finitura cuoio disponibile in tre tipologie di pelle: Soffio, Setanil e Natural Velour. I bordi sono realizzati a tono su tono se non viene specificata alcuna preferenza.



A TIMELESS DESIGN THAT ROUSES THE MOST VIVID OF DREAMS, A TIME SO FAR AWAY IN THE PAST BUT SO NEAR IN THE FUTURE.
UN DESIGN SENZA TEMPO CHE RISVEGLIA I RICORDI PIU VIVIDI, UN TEMPO COSI LONTANO NEL PASSATO E UN TEMPO COSI VICINO NEL FUTURO.

vogue cuoio bench

STEFANO CONFICCONI

Vogue cuoio bench el. PAN base in leather Setanil 76, el. 66C in fabric Vellus 4, black chromed metal legs.

Vogue cuoio panca el. PAN base in pelle Setanil 76, el. 66C in tessuto Vellus 4, piedi in metallo cromato nero.



Vogue cuoio bed el. 180 in leather Setanil 76, black chromed metal legs. **Dino bedside** el. KF in Canaletto walnut wood, drawer handle in Setanil 76, black chromed metal legs. **Vogue cuoio bench** el. PAN in leather Setanil 76, el. 12C in fabric Vellus 4, black chromed metal legs.

Vogue cuoio letto el.180 in pelle Setanil 76, piedi in metallo cromato nero. **Dino comodini** el. KF in legno Noce Canaletto, maniglia cassetto in Setanil 76, piedi in metallo cromato nero. **Vogue cuoio panca** el. PAN base in pelle Setanil 76, El. 12C in tessuto Vellus 4, piedi in metallo cromato nero.

CUSHIONS TO DECORATE EACH SPACE
WITH STYLE AND PERSONALITY.
CUSCINI PER ARREDARE GLI SPAZI
CON STILE E PERSONALITÀ.

cushions





chapeau

STEFANO CONFICCONI 2024

modular sofa with metal structure and elastic belts support. The seat is composed of a seating cushion made of expanded polyurethane foam with two densities and acrylic silicon fiber, all covered with a layer of acrylic fiber. The backrests and armrests are in metal with reclining mechanism and are covered with a layer of expanded polyurethane, further covered with acrylic silicon fiber. The deco pillows are upholstered with acrylic silicon fiber. The metal feet are available in three different finishes: painted champagne effect, painted black and black chromed. The leather covering the profile is available in Soffio, Setanil and Natural Velour.

divano modulare con struttura in metallo e supporto di nastri elastici. Seduta composta da un cuscino in poliuretano espanso in 2 densità e fibra acrilica siliconata, il tutto ricoperto da uno strato di falda acrilica. Schienali e braccioli in metallo reclinabili avvolti da uno strato di poliuretano espanso, a loro volta ricoperti da uno strato di fibra acrilica siliconata. I cuscini decorativi sono imbottiti con fibra acrilica siliconata. I piedi sono in metallo, disponibili in 3 diverse finiture: verniciato effetto champagne, verniciato nero o cromato nero. Il profilo è rivestito in pelle disponibile a scelta tra Soffio, Setanil e Natural Velour.

seat height altezza seduta 42 cm 16.5"	seat depth profondità seduta 74 cm 29.1"	arm width larghezza braccio 17/25 cm 6.7"/9.8"	arm height altezza braccio 73 cm 28.7"	feet height altezza piede 16 cm 6.3"
--	--	--	--	--

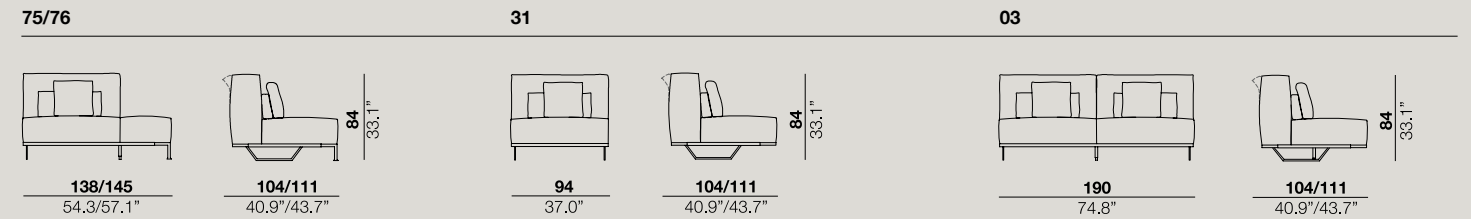
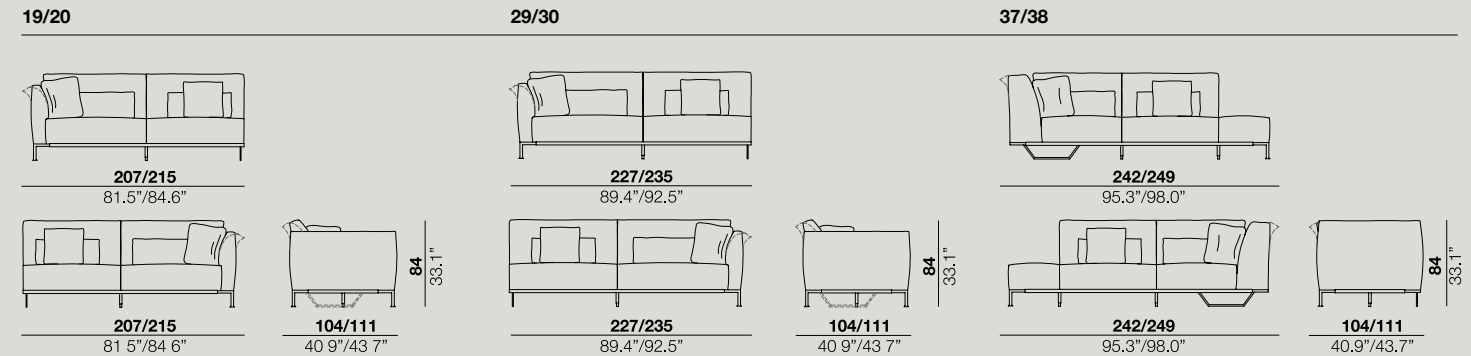
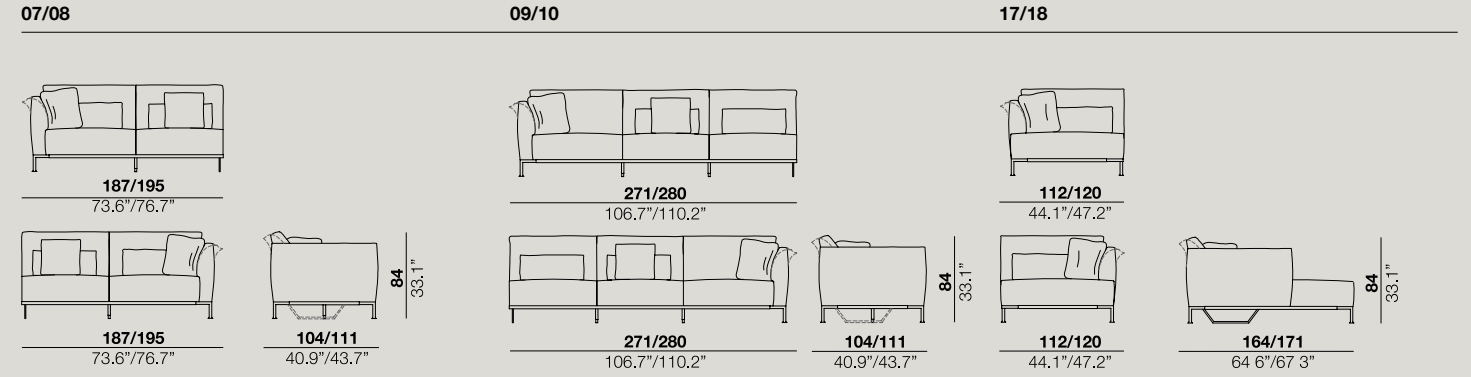
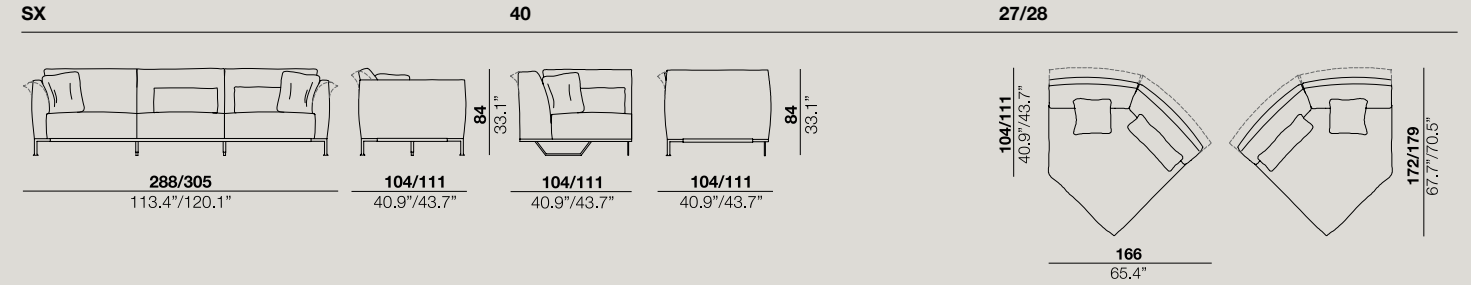
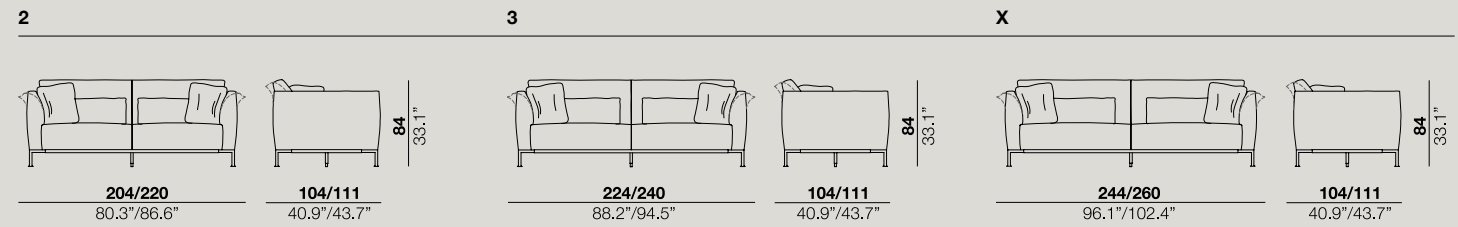
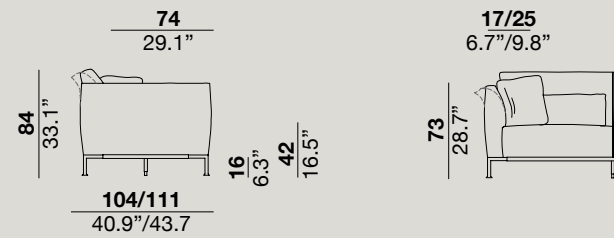

DRM

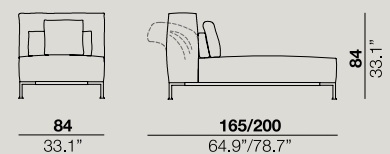

PRT

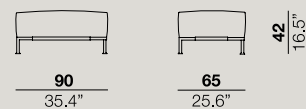

PAN

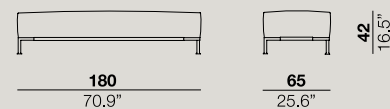

clift

MARCO FUMAGALLI 2019

modular sofa with metal structure and wooden frame. Elastic belts support. Seat cushions in expanded polyurethane foam with three different densities and memory foam covered with acrylic fiber. The backrests and armrests are in metal, covered with expanded polyurethane foam and acrylic fiber. Black plastic legs.

divano modulare con struttura in metallo e telaio in legno. Supporto di nastri elastici. Cuscini di seduta in poliuretano espanso con tre densità differenti e memory foam rivestito con falda acrilica. Schienali e braccioli in metallo rivestiti con poliuretano espanso e falda acrilica. Piedi in polimero nero.

C22

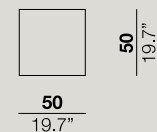

C23

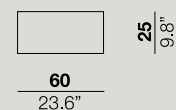

seat height
altezza seduta
45 cm
17.7"

seat depth
profondità seduta
56 cm
22"

arm width
larghezza braccia
28 cm
11"

arm height
altezza braccio
64 cm
25.2"

feet height
altezza piede
4 cm
1.5"

09+37

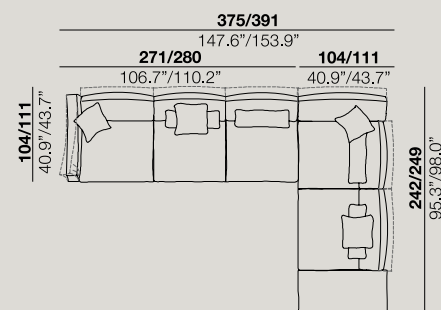

19+28

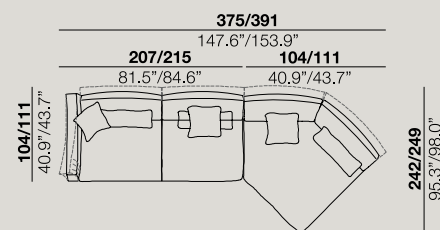

19+18

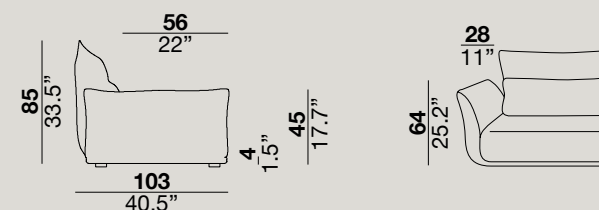
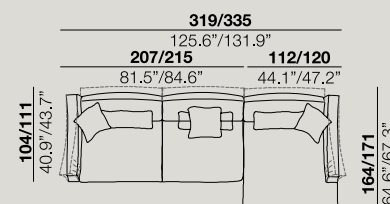

19+37

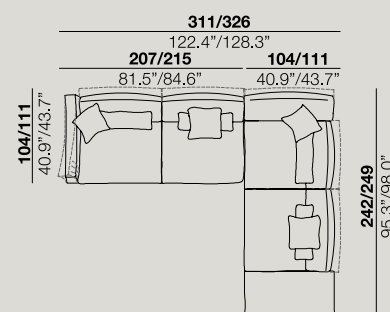

07+18

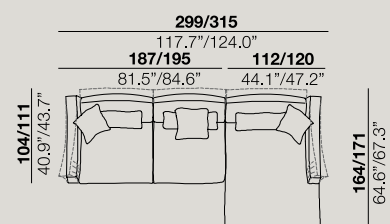

2

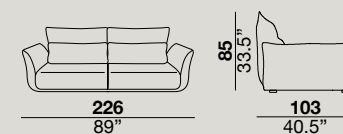

3

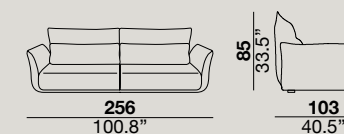

SX

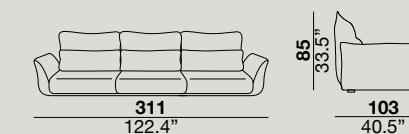

05/06

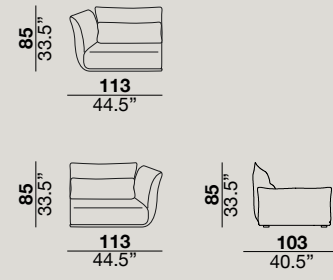

07/08

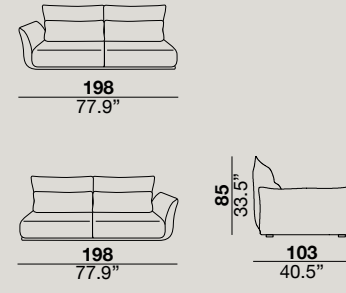

19/20

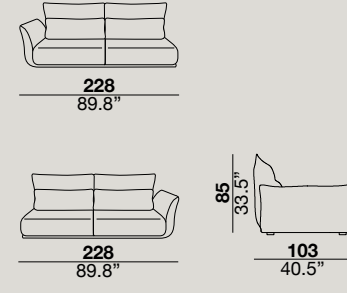

07+18

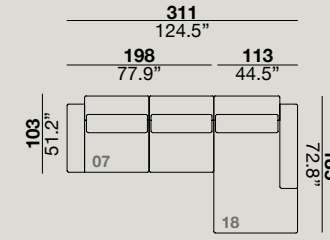

19+18

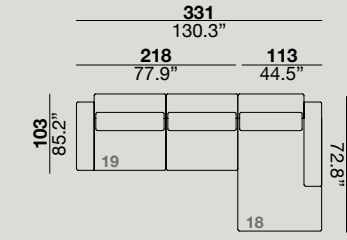

09+18

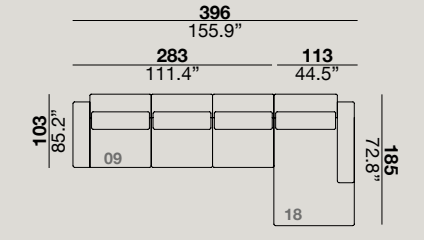

09/10

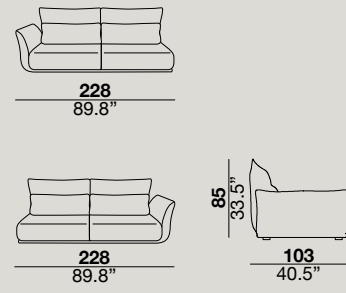

15/16

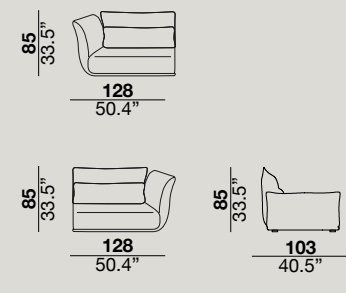

17/18

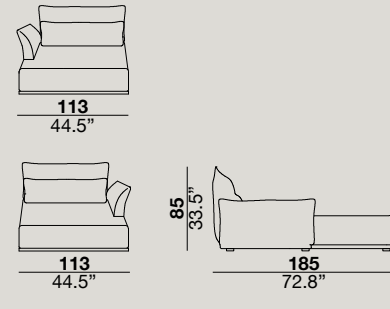

07+40+08

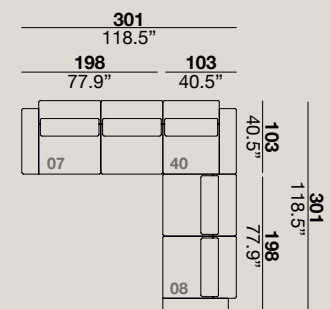

SX+01B+76B

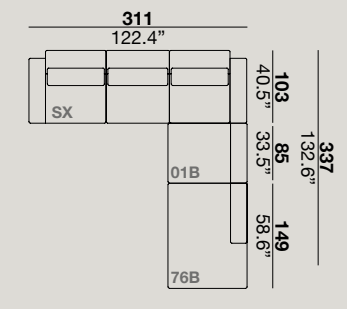

07+08+01B+76B

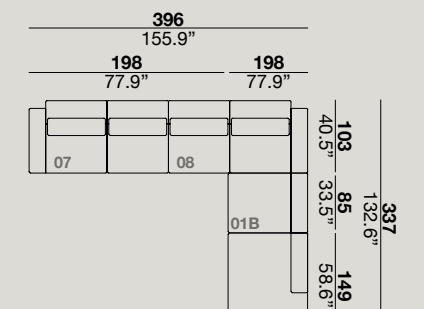

01

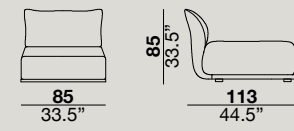

01B

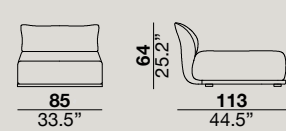

02

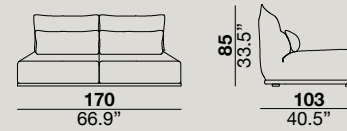

40

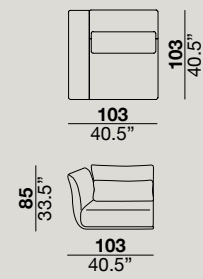

75B/76B

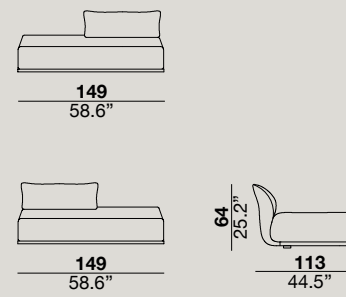

CSR

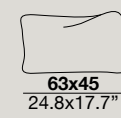



season

STEFANO CONFICCONI 2018

modular sofa with wooden seat structure and elastic belts, covered with two different densities of expanded polyurethane foam. The model is also available with a mechanism which allows to increase the depth of the seat. The backrest and the armrests are in wood covered with expanded polyurethane foam and acrylic silicon fiber. The feet are in black painted wood.

divano modulare con struttura di seduta in legno e supporto di nastri elastici, rivestito in poliuretano espanso in 2 densità differenti. È disponibile anche una versione meccanizzata, che permette l'avanzamento della seduta, aumentandone la profondità. Lo schienale ed i braccioli sono in legno rivestiti in poliuretano espanso ricoperto con fibra acrilica siliconata. I piedi sono in legno verniciato nero.

seat height altezza seduta 41 cm 16.1"	seat depth profondità seduta 66 cm 26"	arm width larghezza braccio 33/45 cm 13/17.7"	arm height altezza braccio 50 cm 19.7"	feet height altezza piede 4 cm 1.5"
--	--	---	--	---

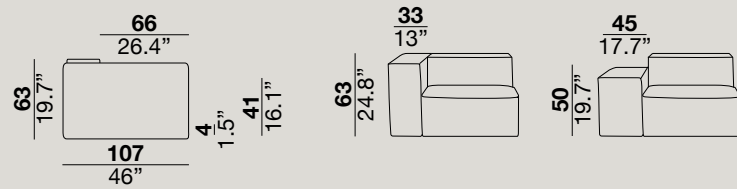

1FA

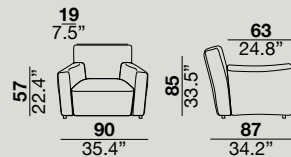

1GO

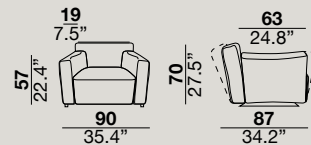

10A

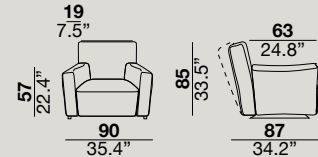

1PI

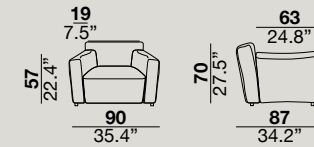

PRP

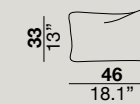

1S/2S

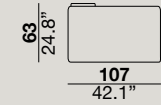
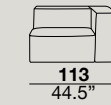
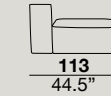

3S/4S

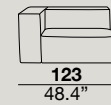

5S/6S

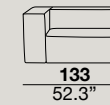

17S/18S

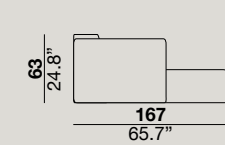
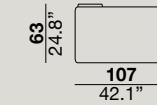
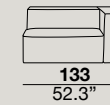
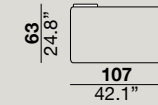
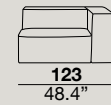
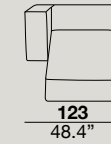

1L/2L

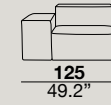

3L/4L

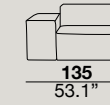

5L/6L

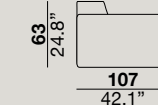
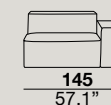
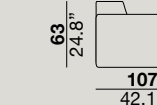
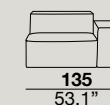
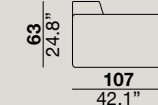
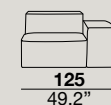
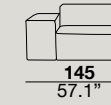

17L/18L

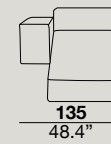

1SM/2SM

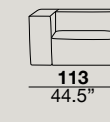

3SM/4SM

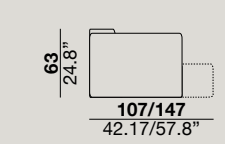
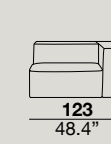
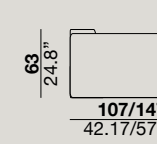
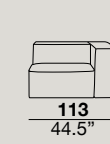
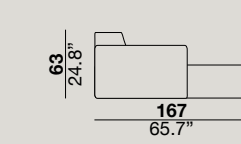
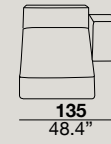
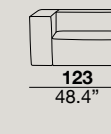

5SM/6SM

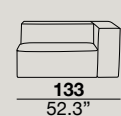
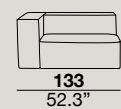

1LM/2LM

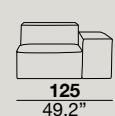
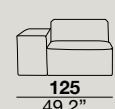

3LM/4LM

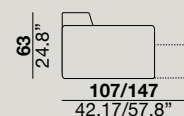
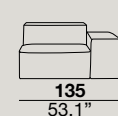
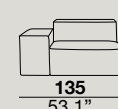

PPR

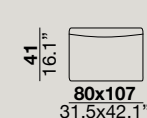

PRT

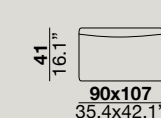

P

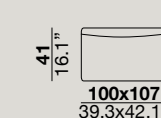

5LM/6LM

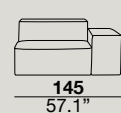
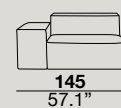

CP

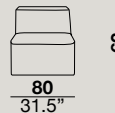

C

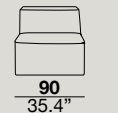
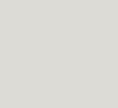

CS



CSM

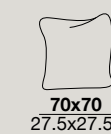

33+(x3)C+40+4S+(x4)CS

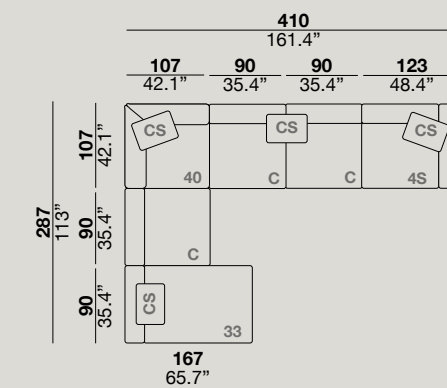

CG

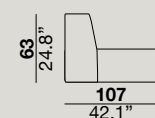

CPM

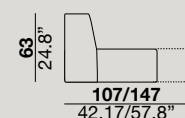
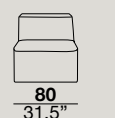

CM

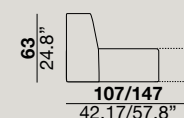
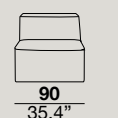

3S+C+4S+(x3)CS

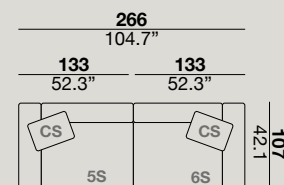

3S+C+18L+(x3)CS

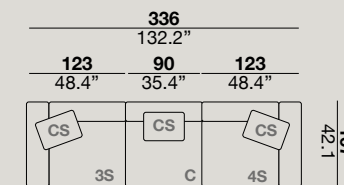

3SM+C+4SM+(2xCSM)

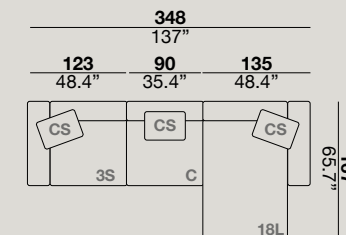

CGM

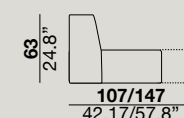

33

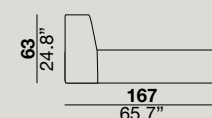
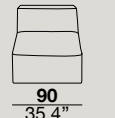

40

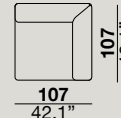



iole

MAURIZIO MANZONI 2024

armchair with metal structure and armrests in solid wood available in 3 different finishes: Canaletto walnut, painted black ash and painted white ash. The woven leather on the armrest is available in three different leathers: Soffio, Setanil and Natural Velour. The backrest is upholstered with expanded polyurethane foam with three densities, covered in acrylic silicon fiber. The seat is made of expanded polyurethane foam covered with acrylic silicon fiber, further covered with an acrylic layer. If no preference is specified, the edges feature tone-on-tone lacquering.

poltrona con struttura in metallo e braccioli in legno massello disponibili in 3 finiture: Noce Canaletto, Frassino nero e Frassino sbiancato. Intreccio bracciolo disponibile in 3 tipologie di pelle: Soffio, Setanil e Natural Velour. Lo schienale è imbottito in poliuretano espanso a 3 densità, ricoperto con fibra acrilica siliconata. La seduta è realizzata in poliuretano espanso ricoperta con fibra acrilica siliconata a sua volta rivesta con falda acrilica. I bordi sono realizzati tono su tono se non viene specificata alcuna preferenza.

seat height altezza seduta	seat depth profondità seduta	arm height altezza braccio	feet height altezza piede
44 cm 17.3"	57 cm 22.4"	50 cm 19.7"	19 cm 7.5"

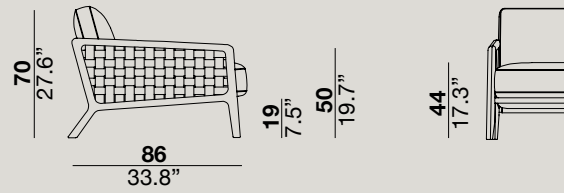

1



jamiro

MARCO FUMAGALLI 2024

armchair with metal structure available in two different finishes: black chromed or matt painted black. The leather seat comes with a "cuoio effect" finishing paired with a high-wearing bonded leather. The seat is available in three different leathers: Soffio, Setanil and Natural Velour. If no preference is specified, the edges feature tone-on-tone lacquering.

poltrona con struttura in metallo, disponibile in due diverse finiture: cromato nero o verniciata nera opaca. Seduta in pelle realizzata con una speciale finitura cuoio, disponibile in tre tipologie di pelle: Soffio, Setanil e Natural Velour. I bordi sono verniciati tono su tono se non viene specificata nessuna preferenza.

seat height altezza seduta	seat depth profondità seduta	arm height altezza braccio	feet height altezza piede
40 cm 15.7"	47 cm 18.5"	67 cm 26.4"	37 cm 14.6"

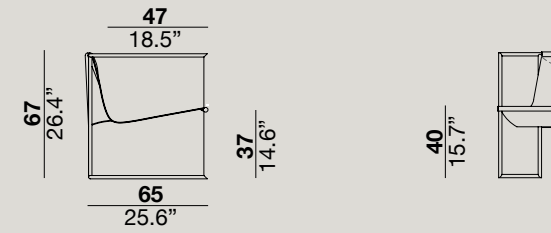

1

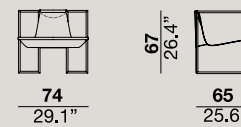



woody

MAURIZIO MANZONI 2023

armchair with a metal frame filled with expanded polyurethane foam, covered with acrylic fiber. Wooden seat frame supported by elastic belts, filled with Polyurethane foam, covered with acrylic fiber. The basement is in beech wood with lacquered finishing available in the following colors RAL: 9005, 9002, 3007 and 6008.

poltrona con fusto in metallo rivestito con poliuretano espanso ricoperto con falda acrilica. Struttura sedile in legno con supporto di nastri elastici, rivestita in poliuretano espanso ricoperto con falda acrilica. Basamento in legno di faggio laccato disponibile nei colori RAL: 9005, 9002, 3007 e 6008.

seat height altezza seduta 42 cm 16.5"	seat depth profondità seduta 59 cm 23.2"	arm width larghezza braccio 10 cm 3.9"	arm height altezza braccio 52 cm 20.5"	feet height altezza piede 25 cm 9.8"
--	--	--	--	--

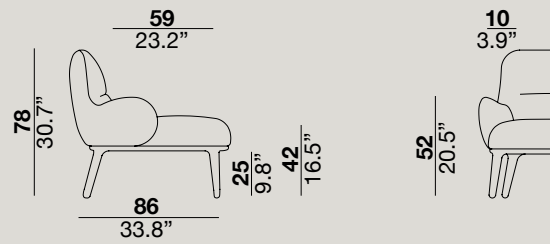

1



vogue cuoio bed

STEFANO CONFICCONI 2024

bed with a metal headboard upholstered with expanded polyurethane foam covered with acrylic silicon fiber. The sommier is made of painted metal with a leather-covered wooden frame with cuoio finish available in three different leathers: Soffio, Setanil and Natural Velour. The metal feet are available in bright chromed or black chromed. If no preference is specified, the edges feature tone-on-tone lacquering. Mattress is not included. Please note: single wooden slat included in the bed.

letto con testiera in metallo imbottita con poliuretano espanso, rivestito con fibra acrilica siliconata. Il sommier è realizzato in metallo verniciato con cornice in legno rivestita in pelle e speciale finitura cuoio, disponibile in 3 tipologie: Soffio, Setanil e Natural Velour. I piedi sono disponibili cromati lucidi o cromati neri. I bordi sono realizzati tono su tono se non viene specificata alcuna preferenza. Il materasso non è incluso. Rete singola a doghe in legno compresa nel letto.

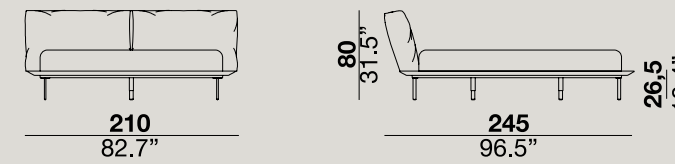

160

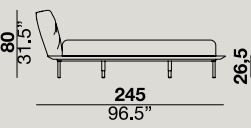
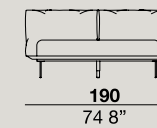

180

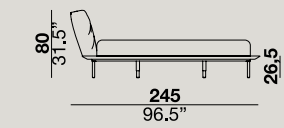
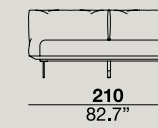

QEN

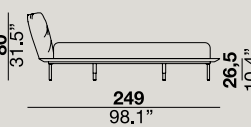
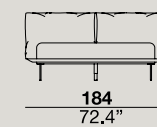

KNG

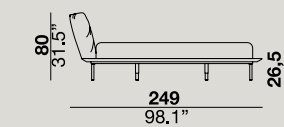
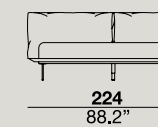

200

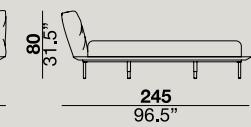
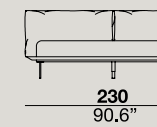

100

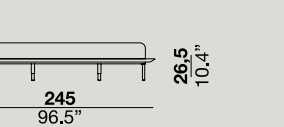
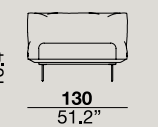

PAN

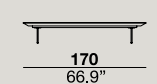

66C

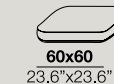

12C





jared bed

MAURIZIO MANZONI 2024

bed with painted metal headboard available in two colors: Champagne and black. The headboard is decorated with woven leather with special raw cut edges finishing, available in three different leathers: Soffio, Setanil and Natural Velour. The standard finishing of headboard back-side, is made of black Romana leather, it is possible to have it in the same leather as the front with an up-charge. The wooden frame is covered with expanded polyurethane foam further covered with acrylic fiber. The metal feet are painted Champagne or black. If no preference is specified, the edges feature tone-on-tone lacquering. The mattress is not included.

letto con testiera in metallo verniciato disponibile in due colori: Champagne e nero. Testata decorata con intreccio pelle accoppiata con finitura cuoio, disponibile in 3 tipologie di pelle: Soffio, Setanil e Natural Velour. Il retro della testata standard è realizzato in pelle Romana nero, è possibile averlo nella stessa pelle del fronte con un supplemento. Sommier in legno ricoperto con poliuretano espanso, rivestito con fibra acrilica. Piedi in metallo verniciato color Champagne o nero. I bordi sono realizzati tono su tono se non viene specificata alcuna preferenza. Il materasso non è incluso.

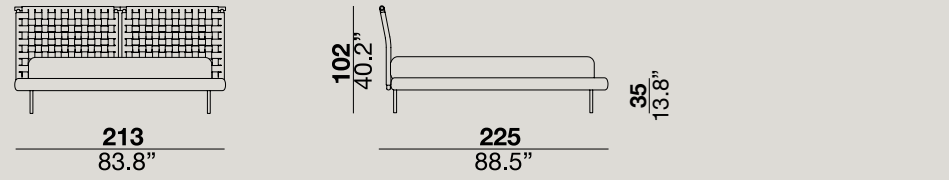

160 180

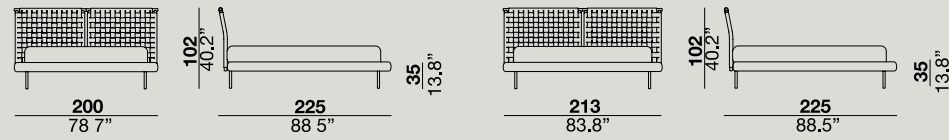

QEN KNG

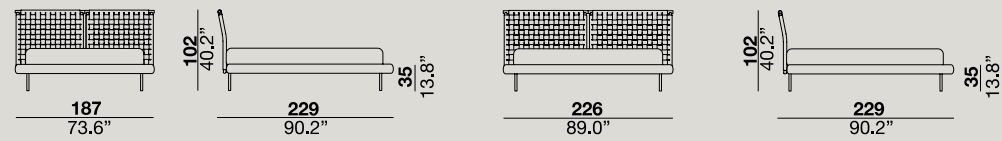

200 100

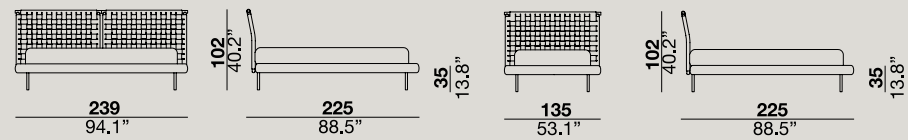

lip

MARCO FUMAGALLI 2022

frame in Canaletto walnut veneered MDF or matt lacquered MDF available in two colors RAL: 3007 black red, 6008 brown green. Top detail in Travertine stone. Metal legs available painted in the same two colors as the frame or black chromed plated or chromed plated.

struttura in MDF impiallacciato Noce Canaletto o MDF laccato opaco disponibile nei colori RAL: 3007 rosso nerastro, 6008 verde brunastro. Dettaglio top in Travertino. Piedi in metallo verniciato disponibili nei due colori della struttura oppure cromato nero o cromato lucido.

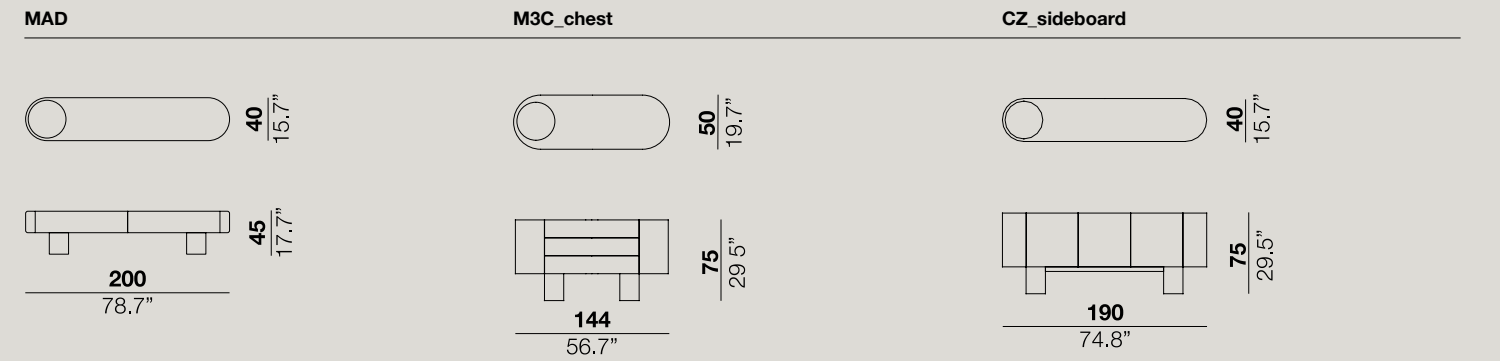



fly

MAURIZIO MANZONI 2020

wooden structure in multi-laminated wood with different finishes: veneered black ash wood or light Lati wood, gloss lacquered or matte lacquered available in different RAL colors: 9005, 3007, 6008 and 9002. Storage unit in glass: 5 closed sides with extra clear or bronze tinted toughened glass, 12 mm thick. Black painted metal base.

struttura in legno multi laminato disponibile con diverse finiture: impiallacciato in legno frassino nero o legno Lati chiaro oppure laccato lucido o opaco nei seguenti colori RAL: 9005, 3007, 6008 e 9002. Struttura in vetro: bussolotto chiuso su 5 lati in vetro extra chiaro temperato o bronzo, spessore 12 mm. Base in metallo verniciato nero.

MDS_right cupboard

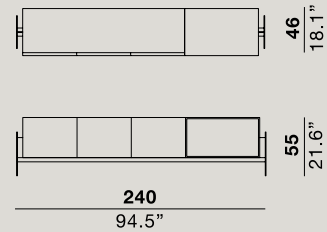

MDD_left cupboard

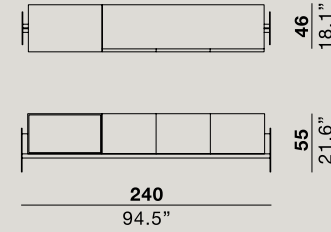

MAX

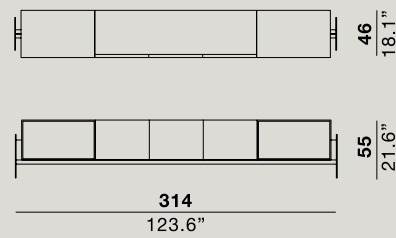

riviera

MARCO FUMAGALLI 2023

table with top available in different finishing:

- in multi-laminated veneered wood with black ash or light Lati finish.
 - in 19 mm toughened glass, painted in baking process with 3 different colors: bronze, blue or green.
- Feet in curved metal available black painted RAL 9005 or black chrome-plated or chrome-plated.

tavolo con top disponibile in diverse varianti:

- in legno multi-laminato impiallacciato con finitura frassino nero o Lati chiaro.
 - In vetro indurito spess. 19 mm, verniciato in cottura in tre colori: bronzato, blu o verde.
- I piedi sono in metallo incurvato, disponibili verniciati nel colore RAL 9005, cromati neri o cromati lucidi.

X20

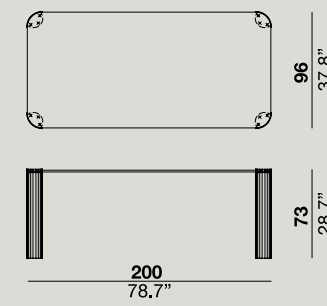

X23

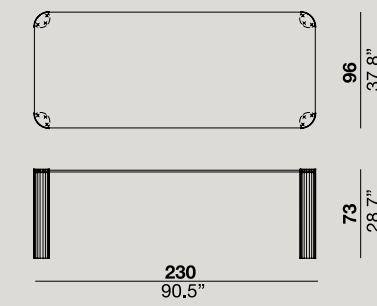

X25

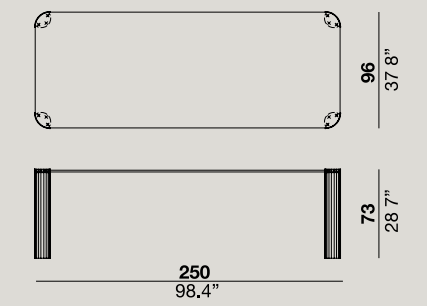



zed

MARCO FUMAGALLI 2024

desk with top central part available in Canaletto walnut or smoked ash wood with matt finish. Leather covered edge available in three different leathers: Soffio, Setanil and Natural Velour. The legs made of MDF comes covered in Soffio, Setanil or Natural Velour.

scrivania con top parte centrale disponibile in legno Noce Canaletto o frassino affumicato finitura opaco. Bordo rivestito in pelle a scelta: Soffio, Setanil o Natural Velour. Il piede di sostegno realizzato in MDF può essere rivestito in tre tipologie di pelle: Soffio, Setanil o Natural Velour.

Z16

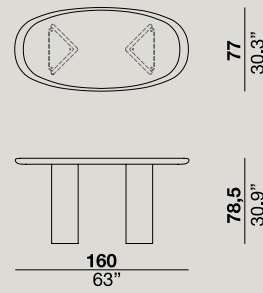

byron

MARCO FUMAGALLI 2024

coffee tables with veneered wood top in two finishes: Canaletto walnut wood and black ash. Glass feet available in two finishes: extra clear and smoked.

tavolini con top in legno impiallacciato con due finiture: Noce Canaletto e frassino nero. Piedi in vetro disponibile in due finiture: extra chiaro e fumè.

TT

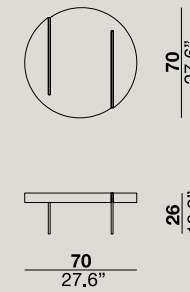

TQ

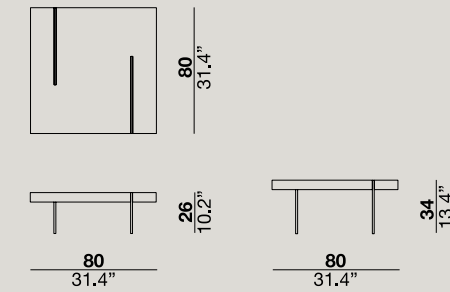

TO

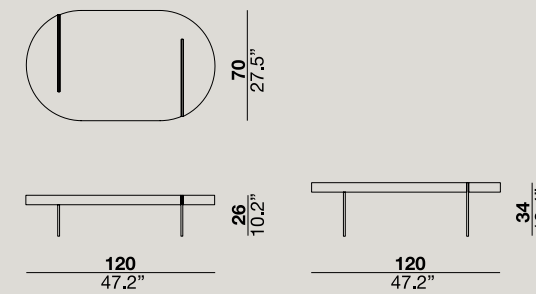



tappo

CIERRE LAB 2024

coffee tables with top in Travertine stone or solid Canaletto walnut wood. Wooden base painted black. Structure in high-wearing plastic covered in leather with special raw cut edges finishing, available in three different leathers: Soffio, Setanil and Natural Velour. If no preference is specified, the edges feature tone-on-tone lacquering.

tavolini con top in Travertino o legno massello noce Canaletto. Struttura base in legno verniciato nero. Struttura corpo polimero ad alta resistenza, rivestito in pelle con finitura cuoio disponibile in tre tipologie di pelle: Soffio, Setanil, Natural Velour. I bordi sono realizzati tono su tono se non viene specificata alcuna preferenza.

TP

TM

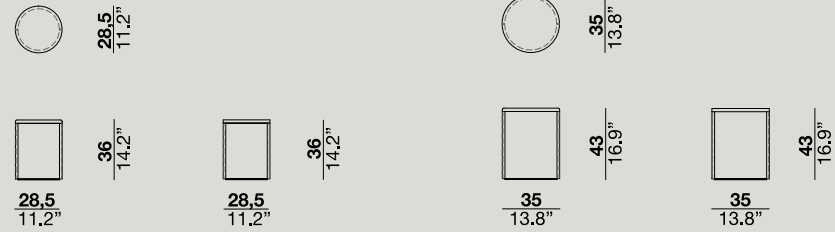

TG

TX

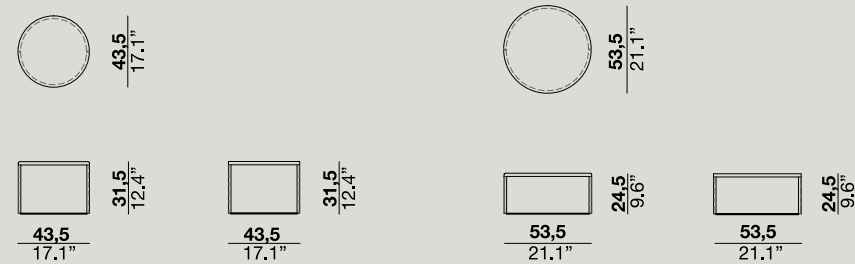

helix

MAURIZIO MANZONI 2024

coffee tables with glass top available in two finishes: extra clear and bronze. Metal base covered in leather with special raw cut edges finishing, available in three different leathers: Soffio, Setanil and Natural Velour. If no preference is specified, the edges feature tone-on-tone lacquering. Metal support plate available in bright chromed or black chromed finish.

tavolini con top in vetro disponibile in due colori: extra chiaro e bronzo. Basamento in metallo rivestito in pelle con finitura cuoio, disponibile in tre tipologie di pelle: Soffio, Setanil, Natural Velour. I bordi sono realizzati tono su tono se non viene specificata alcuna preferenza. Piastra di appoggio in metallo disponibile cromata lucida o cromata nera.

TAT

TBT





riviera coffee table

MARCO FUMAGALLI 2023

top made of 15 mm toughened glass, painted in baking process with 3 different colors: bronze, blue or green. Legs in curved metal, available in two different height cm 29 or cm 36 (except the table TAT), can be black painted RAL 9005 or black chrome-plated or chrome-plated.

tavolini con top in vetro spess.15mm indurito e verniciato in cottura, disponibili in tre colori: bronzato, blu o verde. I piedi in metallo incurvato, disponibili in due altezze cm 29 o cm 36 (ad esclusione del tavolo TAT), sono realizzabili verniciati nel colore RAL 9005, cromati neri o cromati lucidi.

TQ

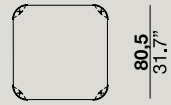

TR

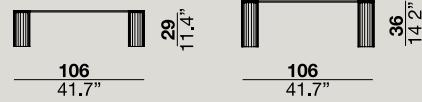
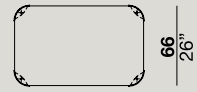

TT

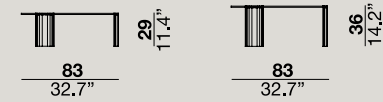
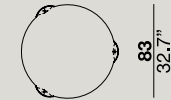

dino

MARCO FUMAGALLI 2024

drawer with soft-closing mechanism available in Canaletto walnut wood. Leather handle in Setanil 76. Metal base available in bright chromed or black chromed finish.

cassetto con soft closing disponibile in finitura Noce Canaletto. Maniglia in pelle Setanil 76. Base in metallo disponibile cromata lucida o cromata nera.

KF

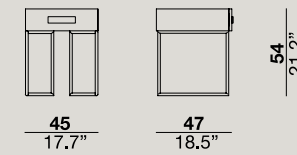

TP

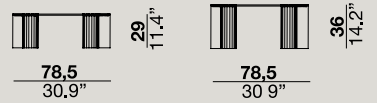

TAT

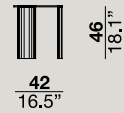
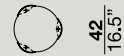



dama coffee table

MAURIZIO MANZONI 2024

coffee tables with removable container top in two finishes: Travertine stone and solid Canaletto walnut wood. The wooden base is painted black. The support metal structure is painted black, the external structure is made of woven leather with special raw cut edges finishing available in three different leathers: Soffio, Setanil and Natural Velour. If no preference is specified, the edges feature tone-on-tone lacquering.

tavolini con top removibile per contenitore in due finiture: Travertino e legno massello Noce Canaletto. Base in legno verniciata nera. Struttura di sostegno in metallo verniciato nero, struttura esterna in pelle intrecciata finitura cuoio disponibile in tre tipologie di pelle: Soffio, Setanil e Natural Velour. I bordi sono realizzati tono su tono se non viene specificata alcuna preferenza.

TP2

TM2

TG2

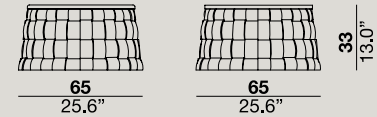
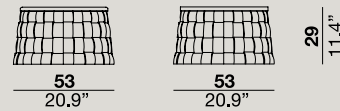

dama pouf

MAURIZIO MANZONI 2024

seat upholstered with expanded polyurethane foam with two different densities covered with acrylic fiber. Woven leather structure with special raw cut edges finish available in three different leathers: Soffio, Setanil and Natural Velour. If no preference is specified, the edges feature tone-on-tone lacquering. The base is made of painted black wood.

seduta in poliuretano espanso con 2 densità rivestite con falda acrilica. Struttura in pelle intrecciata finitura cuoio, disponibile in tre tipologie di pelle: Soffio, Setanil e Natural Velour. I bordi sono realizzati tono su tono se non viene specificata alcuna preferenza. Base in legno verniciata nera.

TM3

TG3

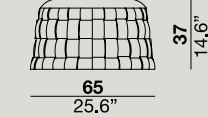
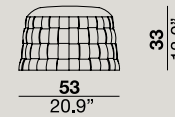



dama basket

MAURIZIO MANZONI 2024

container with black painted wooden base. Woven leather structure with special raw cut edges finishing available in three different leathers: Soffio, Setanil and Natural Velour. If no preference is specified, the edges feature tone-on-tone lacquering.

contenitore con base in legno verniciata nera. Struttura in pelle intrecciata con finitura cuoio disponibile in tre tipologie di pelle: Soffio, Setanil e Natural Velour. I bordi sono realizzati tono su tono se non viene specificata alcuna preferenza.

TP1

TM1

TG1

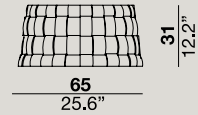
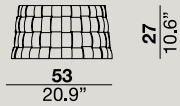
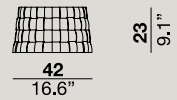

jared bench

MAURIZIO MANZONI 2024

painted metal structure available in two colors: Champagne and black. Seat made of woven leather with special raw cut edges finish available in three different leathers: Soffio, Setanil and Natural Velour. If no preference is specified, the edges feature tone-on-tone lacquering.

struttura in metallo verniciata disponibile in due colori: Champagne e nero. Seduta in pelle intrecciata finitura cuoio disponibile in tre tipologie di pelle: Soffio, Setanil e Natural Velour. I bordi sono realizzati tono su tono se non viene specificata alcuna preferenza.

PAQ

PAN

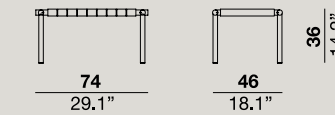
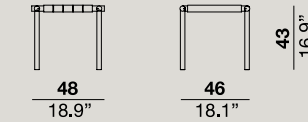
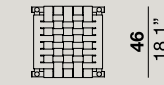

Ad_concept **Cortez Design House**
Images **Gio Sormani**
Styling **Veronica Leali**
Styling contributor **Alessia Biasion**

Thanks

Atelier Areti
Cuore Carpenito
Elena Milani
Federica Bubani
Jaipur Rugs
Lavinia Fantappie
Martinelli Luce
Masserano Cashmere
Mediterranea
Michela Grossi
Nason Moretti
Nassi Lamps
Nodus Rugs
Penta Light
Picta design
Rito Collection
Saceramics
SF ceramica
Studio Delta Pottery
Vero International
Viva Ceramics
Vs Ceramics
Zeta Ceramica

Verde
Bosco Forlì

Artwork
De Grandis
Nicola Veneziani - Sensee

Print
Grafiche Antiga

cierre imbottiti srl
via giovanni ansaldo, 2
47122 villa selva, forlì (fc), italy
t. (+39) 0543 785911
f. (+39) 0543 782493
info@cierreimbottiti.com
www.cierreimbottiti.com

Made in Italy 100%



cierre1972

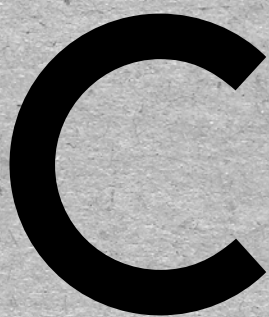

COLLECTION24